



Schlage Utility Software

For Pidion BM-150 / BM-170 Devices
User's Guide



Important Information

Customer Service

U.S.A.: 877-671-7011

www.schlage.com/support

Copyright

©2018 Allegion

Revision

This document has been updated for SUS Rev 6.6.3.

Check www.schlage.com/support for latest SUS revisions.

Warranty

LIMITED WARRANTY: COMMERCIAL APPLICATIONS

12 Month Limited Warranty

Schlage Lock Company (the “Company”) extends a 12 month limited warranty from the original date of purchase to the Original User of the products manufactured by the Company (the “Product”) against defects in material and workmanship. Certain Products contain restrictions to this limited warranty, additional warranties or different warranty periods. Please see below for specific Product warranty information.

The provisions of this warranty do not apply to Products: (i) used for purposes for which they are not designed or intended; (ii) which have been subjected to alteration, abuse, misuse, negligence or accident; (iii) which have been improperly stored, installed, maintained or operated; (iv) which have been used in violation of written instructions provided by Schlage; (v) which have been subjected to improper temperature, humidity or other environmental conditions (i.e., corrosion); or (vi) which, based on Schlage’s examination, do not disclose to Schlage’s satisfaction non-conformance to the warranty. Additionally, Schlage will not warrant ANSI A156.2 Grade 2 lever Product installed in educational facilities and student housing.

Small Format Interchangeable Core (SFIC) Warranty: This limited warranty also applies to Schlage locks and housings when used with another manufacturer’s cores, or to Schlage cores (i.e. SFIC) when used in another manufacturer’s locks and housings. The use of unauthorized cylinder cams or other components with the Products shall void this warranty.

Everest® Primus® Limited Lifetime Key Breakage Warranty: A limited lifetime warranty is provided to the Original User against key breakage, subject to the restrictions of this limited warranty.

AD-Series 1-Year Warranty for electronic locks, reader modules, PIM400, and PIB300: A limited warranty is provided to the Original User for one (1) year from the date of installation, not to exceed 24 months from date of shipment from the factory, subject to the restrictions of this limited warranty.

CO-Series 1-Year Warranty for electronic locks, reader modules: A limited warranty is provided to the Original User for one (1) year from the date of installation, not to exceed 24 months from date of shipment from the factory, subject to the restrictions of this limited warranty.

ADDITIONAL TERMS & CONDITIONS APPLYING TO COMMERCIAL APPLICATIONS OF COMMERCIAL PRODUCTS

What the Company Will Do: Upon return of the defective Product to the Company, the Company’s sole obligation, at its option, is to either repair or replace the Product, or refund the original purchase price in exchange for the Product.

Original User: This warranty only applies to the Original User of Products. This warranty is not transferable.

What is Not Covered: The following costs, expenses and damages are not covered by the provisions of this limited warranty: (i) labor costs including, but not limited to, such costs as the removal and reinstallation of Products; (ii) shipping and freight expenses required to return Products to Schlage; and (iii) any other incidental, consequential, indirect, special and/or punitive damages, whether based on contract, warranty, tort (including, but not limited to, strict liability or negligence), patent infringement, or otherwise, even if advised of the possibility of such damages. Some local laws do not allow the exclusion or limitation of incidental or consequential damages, so the above exclusion or limitation may not apply to you.

How Local Law Applies: This warranty gives you specific legal rights, and you may also have other rights as otherwise permitted by law. If this Product is considered a consumer product, please be advised that some local laws do not allow limitations on incidental or consequential damages or how long an implied warranty lasts, so that the above limitations may not fully apply. Refer to your local laws for your specific rights under this warranty.

Warranty Claims: If you have a claim under this warranty, please contact Schlage Customer Service (877-671-7011) for repair, replacement or refund of the original purchase price in exchange for the return of the Product to Schlage.

Miscellaneous: The Company does not authorize any person to create for it any obligation or liability in connection with the Product. The Company’s maximum liability hereunder is limited to the original purchase price of the Product. No action arising out of any claimed breach of this warranty by the Company may be brought by the Original User more than one (1) year after the cause of action has arisen.

Contents

ii	Important Information	62	Legacy Locks and Controllers
ii	Customer Service	62	Program a Lock or Controller
ii	Copyright	63	Collect Audits and Update a Lock
ii	Revision	63	View Properties
iii	Warranty	64	Edit Properties
5	Overview	64	Update Firmware
5	Supported Devices	65	Link a Door to a Legacy PIM
6	SUS Functions by Device	65	Diagnostics
7	Getting Started	66	Troubleshooting
9	Synchronization Software	66	General Troubleshooting
13	Install/Update Schlage Utility Software	67	Error Codes
		71	Remove the Schlage Utility Software
14	Icon Definitions	72	Glossary
15	Logging In	75	Appendix A: SUS Update Guide
15	Start the Schlage Utility Software	77	Appendix B: Device Firmware Update
16	Log in as a Manager	77	AD-Series On-Line Devices: Over Network Reprogramming (ONR).
16	Log in as an Operator	77	AD-Series and CO-Series Device Firmware Update
		81	Legacy Device Firmware Update
17	Schlage Utility Software Options	85	Appendix C: Change Lock Class
17	Connection Type	85	AD-Series Locks
18	Door List	89	Appendix D: Device Template
18	Update Mode	90	Create a Device Template
18	SUS Password	90	Copy a Saved Device Template
18	Coupling Password	91	Appendix E: Diagnostic Data Log
18	Language	91	About Diagnostic Data Log Feature
19	Device Template Feature	91	Supported Locks
19	Diagnostic Data Log Feature	91	Prerequisites
		92	Diagnostic Data Log Menu
20	Connecting the HHD	94	Index
20	Connecting the Handheld Device		
24	AD-Series Locks and Controllers		
24	Couple HHD to Lock		
25	Couple HHD to PIM400 or PIB300		
25	Couple HHD to WRI400/CT5000		
26	Program a Lock or Controller		
26	Collect Audits and Update Lock		
27	View Properties		
27	Edit Properties		
27	Edit Reader Properties		
28	Put PIM400 into Link Mode		
28	Put PIM400 into Diagnostics Mode		
28	Update Firmware		
28	Diagnostic Data Log Feature		
29	AD-Series Readers		
31	Lock Properties		
42	Controller Properties		
57	CO-Series Locks		
57	Couple HHD to Lock		
57	Program a Lock		
58	Collect Audits		
58	View Properties		
59	Edit Properties		
59	View Reader Properties		
59	Edit Reader Properties		
59	Update Firmware		
60	Lock Properties		

Overview

The Schlage Utility Software is an application that runs on the Schlage Handheld Device (HHD). It is used to configure, edit and program all supported devices.

Supported Devices

Locks and Controllers	HHD Model Compatibility		Locks and Controllers	HHD Model Compatibility				
	BM-150	BM-170		BM-150	BM-170			
AD-Series Locks	AD-200	•	•	AD-Series and Legacy Controllers	PIM400	•	•	
	AD-201	•	•		WRI400	•	•	
	AD-250	•	•		WPR400	•	•	
	AD-300	•	•		PIB300	•	•	
	AD-301	•	•		CT5000 Controller	•	•	
	AD-302	•	•		CT500 Controller	•	•	
	AD-400	•	•		CT1000 Controller	•	•	
	AD-401	•	•		Legacy PIM	WRI ¹	•	•
	AD-402	•	•			WPR ¹	•	•
			WPR2 ¹			•	•	
CO-Series Locks	CO-200	•	•		WSM ¹	•	•	
	CO-220	•	•		CL Campus Lock Controller	•	•	
	CO-250	•	•					
Legacy Locks	KC2-5100	•	•					
	KC2-5500	•	•					
	KC2-9000	•	•					
	CM5100	•	•					
	CM5500	•	•					
	CM5200	•	•					
	CM5600	•	•					
	CM5700	•	•					
	CM993	•	•					
	CL5100	•	•					
	CL5500	•	•					
	CL5200	•	•					
	CL5600	•	•					
	CL993	•	•					
	BE367	•	•					

1. These devices cannot be configured directly. They are configured through the legacy PIM.

SUS Functions by Device

AD-Series Devices	AD-200²	AD-250	AD-300²	AD-302	AD-400^{1,2}	AD-402¹	CT5000	PIB300	PIM400	WPR400^{1,2}	WRI400¹
Collect Audits	.	.					.				
Edit Lock Properties				
Edit PIB300 properties								.			
Edit PIM400 properties									.		
Edit Door Properties				
Update Firmware
Couple HHD to Device
Set Date/Time
Diagnostics									.		
Change Lock Class

- AD-Series wireless device properties may also be viewed or edited through the PIM400.
- These devices work with the FIPS201 standard. AD-200 will become AD-201, AD-300 will become AD-301, and AD-400 will become AD-401 when a FMK reader is attached. If the FMK reader is attached to the WPR400, it will become WPR401.

CO-Series Devices	CO-200	CO-220	CO-250
Collect Audits	.	.	.
Edit Lock Properties	.	.	.
Update Firmware	.	.	.
Couple HHD to Device	.	.	.
Set Date/Time	.	.	.

Legacy Devices	KC2	CM	CL	BE367	CT500/1000	CL Controller	Legacy PIM	WA¹	WPR2¹	WSM¹	WRI¹
Collect Audits					
Edit Lock Properties					
Update Firmware Update				
Edit Legacy PIM properties							.				
Edit WAPM Properties						
Diagnostics							.				

- Legacy wireless access point devices cannot be configured directly. They are configured through the legacy PIM.

Getting Started

The Schlage Utility Software (SUS) is a software application that runs on a Windows CE based handheld device. It is used to transfer data files between the access control software and locks and controllers.

Quick Start

To begin using the SUS, review the following topics:

- 1 Download and Install Synchronization Software ([page 9](#))
- 2 Connect the HDD to your PC ([page 13](#))
- 3 Configure the Synchronization Software ([page 10](#))
- 4 Update SUS ([page 13](#))
- 5 Start SUS ([page 15](#))
- 6 Connecting the Handheld Device to a Lock or Non-Lock Device ([page 20](#))

Handheld Devices









BM-150 HDD



BM-170 HDD

System Components

ID	BM-150	BM-170	Description
HHD KIT	•	•	Handheld Device pre-loaded with SUS, USB Cable
HH-USB 	•	•	Cable used to connect HHD to AD- and CO-Series products.
HH-Serial 	•	n/a	Cable used to connect HHD to CIP for programming legacy CM/CL/KC products.
PIMWA-CV 	•	•	Null converter used to connect HHD to WA Series Legacy PIM, using the HH-Serial Cable.
CIP (P512-112) 	•	n/a	CIP Module used with HH-Serial Cable for programming legacy CM/CL/KC products.
HH-2PIN Serial Black 	•	•	Cable used to connect HHD for programming legacy CM/CL/KC products. Must have SUS 6.3.3 in HHD to support the HH-2PIN Serial cable.
HH-2PIN Serial Gray 	•	•	Cable used to connect HHD for programming legacy BE367/FE210 products. Must have SUS 6.5.3 in HHD to support the HH-2PIN Serial cable.

Synchronization Software

About Synchronization Software

Synchronization software is software that your computer uses to interface and synchronize with the handheld device. This software is used to install and update software applications on your handheld device. When installed and configured properly, files will be automatically transferred between your computer and the handheld device when the handheld device is connected to the computer.

→ This software may already be installed on your computer.

Download and Install Synchronization Software

- 1 Download the software that matches your operating system.
 - Windows 10, Windows 8, Windows 7 and Windows Vista:
 - 32 Bit: <http://www.microsoft.com/en-us/download/details.aspx?id=14>
 - 64 Bit: <http://www.microsoft.com/en-us/download/details.aspx?id=3182>
 - Windows XP and Windows 2000:
 - 32 and 64 Bit: <http://www.microsoft.com/en-us/download/details.aspx?id=15>
- 2 Launch the installer and follow the on-screen instructions.

Configure Synchronization Software

Microsoft ActiveSync is for use with Windows XP and Windows 2000 operating systems.

Microsoft ActiveSync

- 1 Connect the handheld device to the computer's USB port. The **Synchronization Setup Wizard** will appear.
- 2 Click the **Next** button.
- 3 Uncheck the check box next to **Synchronize directly with a server**.
- 4 Click the **Next** button.
- 5 Uncheck all the check boxes except for the check box next to **Files**.
- 6 The **File Synchronization** window will appear. Click **OK**.
- 7 Click the **Finish** button.

A new folder will be created on the computer to store the synchronized files.

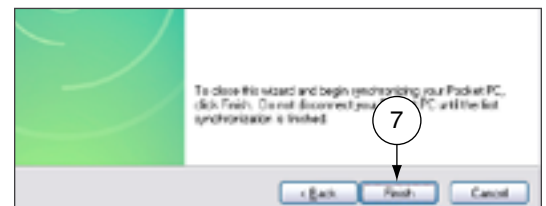
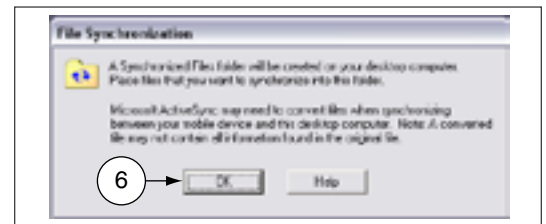
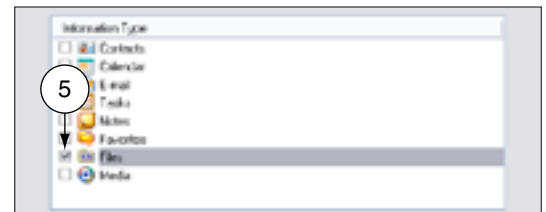
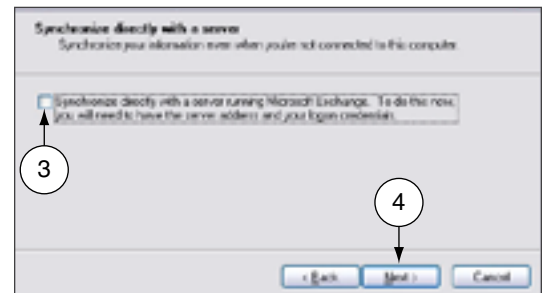

Microsoft Windows Mobile Device Center is for use with Windows 10, Windows 8, Windows 7 and Windows Vista operating systems.

Microsoft Windows Mobile Device Center

- 1 Open the Windows Mobile Device Center from the computer.
- 2 Connect the handheld device to your computer's USB port.
- 3 Click **Setup your device**.
- 4 Click to uncheck all check boxes except for the **Files** check box.
- 5 Click the **Next** button.
- 6 Type a name for the device in the **Device name** box.
- 7 Check the **Create a shortcut on the Desktop...** checkbox.
- 8 Click the **Set Up** button.

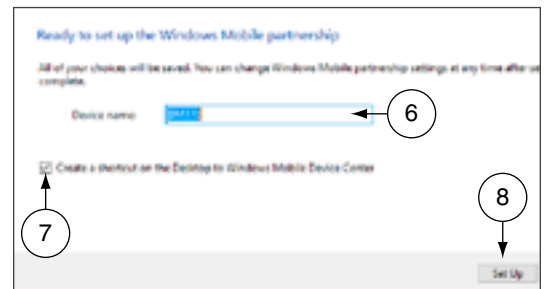
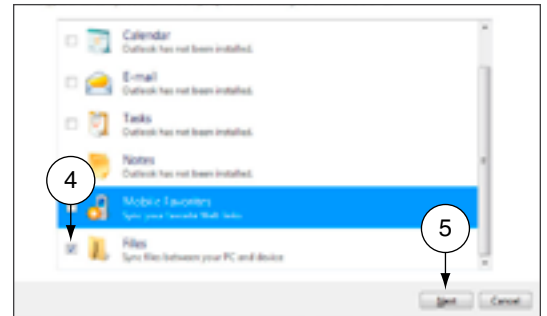

Synchronization software must be installed so that the handheld device can communicate with the computer. See **Synchronization Software** on page 9 for more information.

Locate the Synchronization Folder

The synchronization software looks in this folder for files that should be synchronized with the handheld device. When you configure your access control software, you need to know the location of this file on your computer.

Microsoft ActiveSync

- 1 Connect the HHD to the PC and allow ActiveSync to start.
 - ➔ If Microsoft ActiveSync does not open automatically, click on **Start > Programs > Microsoft ActiveSync**.
- 2 In the bottom half of the ActiveSync screen, double click on the **Files** folder.
- 3 Look for the box, under the text **On this computer, synchronize the files in this folder:**. This box contains the path to the synchronization folder.
 - ➔ This path may extend beyond the edges of the box. Make sure to view the entire path.
- 4 To ensure the path is entered into the access control software correctly, highlight the path and then copy (Ctrl + C) and paste (Ctrl + V) it into the access control software.

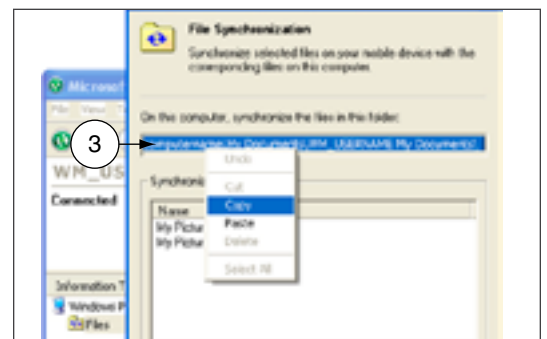
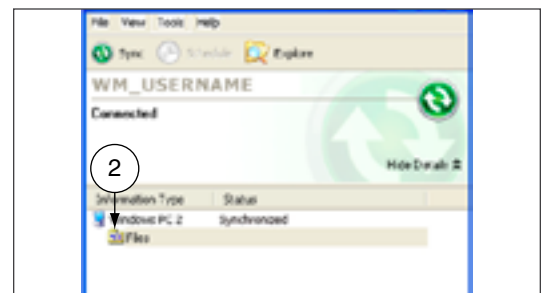

Microsoft Windows Mobile Device Center

- 1 If Microsoft Windows Mobile Device is not already open, click on **Start > Programs > Microsoft Windows Mobile Device Center**.
- 2 Click **Set up your device**.
- 3 Click **Mobile Device Settings**.
- 4 Click **Change content sync settings**.
- 5 Click **Sync Settings**.
- 6 The sync folder path is located below the **Files** icon.
- 7 To ensure the path is entered into the access control software correctly, highlight the path and then copy (Ctrl + C) and paste (Ctrl + V) it into the access control software.

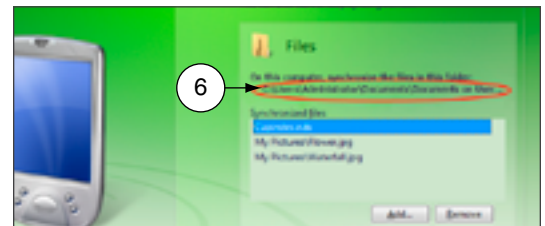
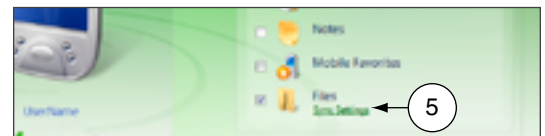
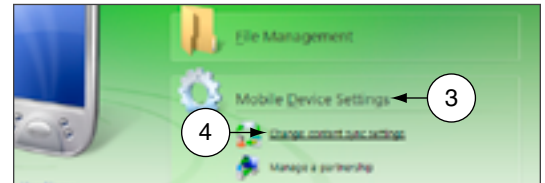

Connect the Handheld Device to the PC

If the HHD does not automatically synchronize with the PC, be sure that the SUS application is not running. The SUS will prevent USB communication with your PC.

- 1 Locate the HH-USB cable that came in the box with the handheld device. Insert the USB end into the computer's USB port.
- 2 Power on the handheld device.
- 3 Insert the other end of the cable into the bottom of the handheld device.

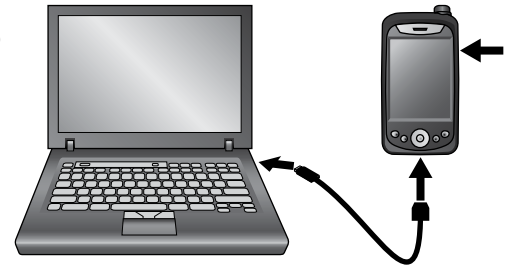

Connecting the Handheld Device to the PC









Install/Update Schlage Utility Software

Although SUS is already installed on your handheld device, you should make sure you have the latest revision of the software.

Synchronization software must be installed and configured on your computer in order for these steps to work properly. See [Download and Install Synchronization Software](#) on page 9 for more information.

- 1 Download the installer (Schlage Utility Setup Ver x.x.xx.exe, version will vary) from www.schlage.com/support.
- 2 Make sure you have already installed and configured the synchronization software.
- 3 Make sure the handheld device is connected to the computer's USB port and is turned on.
- 4 Launch the installer.
- 5 Follow the on-screen instructions. The synchronization software will automatically transfer the software to the handheld device.
- 6 When updating Schlage Utility Software all passwords are reset to their defaults.
 - See [Appendix A: SUS Update Guide](#) on page 75 for detailed instructions about upgrading the Schlage Utility Software on the Handheld Device.

Icon Definitions

	Lock
	Non-Lock Device
	New lock data file has not been updated
	Lock update completed
	Information
	Warning
	Error
	Information is being exchanged with the device
	Firmware Package

Logging In

You can log in to the Schlage Utility Software (SUS) as either a Manager or an Operator. The Manager role has access to all commands. The Operator role has access only to limited commands.

	Manager	Operator
Lock Properties	•	•
Program Lock	•	•
Firmware Update	•	
Change Lock Class	•	
Couple HHD to Device	•	
Set Date/Time	•	
Diagnostic Data Log	•	•
Door Properties	•	•
PIM properties	•	•
Diagnostics	•	
SUS Password	•	•
Coupling Password	•	
Language	•	•
Auto/Manual Update	•	•
List All/Pending Doors	•	•
USB/Serial Connection	•	•

Start the Schlage Utility Software

See [Log in as a Manager on page 16](#) or [Log in as an Operator on page 16](#) for more information.

- 1 On your handheld device, tap the **Start** menu.
- 2 Tap **Programs**.
- 3 Tap the **Schlage Utility Software** icon.
- 4 Log on as either a Manager or an Operator.
- 5 If you are starting the SUS for the first time, change the Manager and Operator passwords, and the Coupling Password, to maintain security.
 - See [SUS Password](#) on page 18 for more information.
 - See [Coupling Password](#) on page 18 for more information.



Log in as a Manager

The default password for both the Manager and Operator is 123456.

If the password is lost, you must reinstall SUS. Customer service cannot retrieve a lost password.

- 1 If you have not already started the Schlage Utility Software, do so now.
→ See [Start the Schlage Utility Software](#) on page 15 for more information.
- 2 Choose **Manager** from the drop-down list.
- 3 Enter the manager password in the password box.
- 4 Select the **Login** button.
→ See [SUS Password](#) on page 18 for more information.

Log in as an Operator

- 1 If you have not already started the Schlage Utility Software, do so now.
→ [See Start the Schlage Utility Software on page 15 for more information.](#)
- 2 Choose **Operator** from the drop-down list.
- 3 Enter the operator password in the password box.
- 4 Select the **Login** button.
→ See [SUS Password](#) on page 18 for more information.

Schlage Utility Software Options

Connection Type

AD/CO-Series devices communicate with the SUS via USB connection. Legacy devices communicate with the SUS via Serial connection. Select this option to match the device type to which you are connecting. If you have both types of devices in your facility, you will need to change this setting during a tour.

- 1 Select **SUS Options**.
- 2 Select **Connection Type**.
- 3 Select **USB Connection** or **Serial Connection**.

Connection Examples



USB Connection with BM-150



Serial Communication with CIP (BM-150 only)



Serial Communication with Null Modem (PIMWA-CV) (BM-150)



Serial Communication with 2PIN Serial Cable (BM-150)



USB Connection with BM-170



Serial Communication with 2PIN Serial Cable (BM-170)



Serial Communication with Null Modem (PIMWA-CV) (BM-170)

Door List

If you want to display only the doors that need to be toured, set this setting to **List Pending Doors**. Select **List All Doors** to display all doors that have been updated and pending.

- 1 Select **SUS Options**.
- 2 Select **Door List**.
- 3 Select **List All Doors** or **List Pending Doors**.

Update Mode

When Auto Update is selected, the SUS will automatically set the date and time in the lock to which it is connected, retrieve the audit and program the lock. When Manual Update is selected, the functions must be independently performed by the user.

→ Manual Update is recommended when managing Legacy Locks.

- 1 Select **SUS Options**.
- 2 Select **Update Mode**.
- 3 Select **Auto Update** or **Manual Update**.

SUS Password

You must be logged in to a role to change the password for that role.

- 1 Select **SUS Options**.
- 2 Select **SUS Password**.
- 3 Enter the old password into the **Old Password** box.
- 4 Enter the new password into the **New Password** box.
 - The new password must be between four (4) and eight (8) characters long and can include capital and lowercase characters, numbers, and symbols.
- 5 Enter the new password again into the **Confirm New Password** box.
- 6 Select the **Submit** button.

This function is available only when logged into the handheld device as a manager.

The default Coupling Password is 123456.

Coupling Password

- 1 Select **SUS Options**.
- 2 Select **Coupling Password**.
- 3 Enter the old password into the **Old Password** box.
- 4 Enter the new password into the **New Password** box.
 - The new password must be between four (4) and eight (8) characters long and can include capital and lowercase characters, numbers, and symbols.
- 5 Enter the new password again.
- 6 Select **Submit**.

Language

- 1 Select **SUS Options**.
- 2 Select **Language**.
- 3 Select the button for the language to which you want to change.
- 4 Select the **OK** button.

Device Template Feature

The Device Template feature facilitates creation, modification and duplication of Device Properties settings across multiple devices. In addition, the Device Template will also report additional device status parameters for a complete summary of the device's health.

Locating the Device Template Feature:

- 1 Select Device Options
 - 2 Select Lock Properties for the connected device
 - 3 Select the Edit or Reader tab
 - 4 The Device Template is at the bottom of the screen
- For details on the Device Template feature, see [Appendix D: Device Template](#) on page **89**.

Diagnostic Data Log Feature

This new feature provides a simple method for AD-Series customers to quickly gather and save important lock-status information in a file.

- For details see [Appendix E: Diagnostic Data Log](#) on page **91**.

Connecting the HHD

Connecting the Handheld Device

The Schlage button will flash green while the lock is waiting to communicate with the HHD. The Schlage button will begin to flash red when communication between the lock the HHD is established.

When communication is established, the device name will be displayed on the SUS main screen.

AD-Series and CO-Series Locks

- 1 Start the Schlage Utility Software.
- 2 Make sure the HHD is in USB Connection Mode. See [Connection Type](#) on page 17 for more information.
- 3 Connect the USB cable to the HHD.
- 4 Plug the HHD USB cable into the lock's USB port located in the bottom of the exterior housing.
- 5 Press the Schlage button twice.

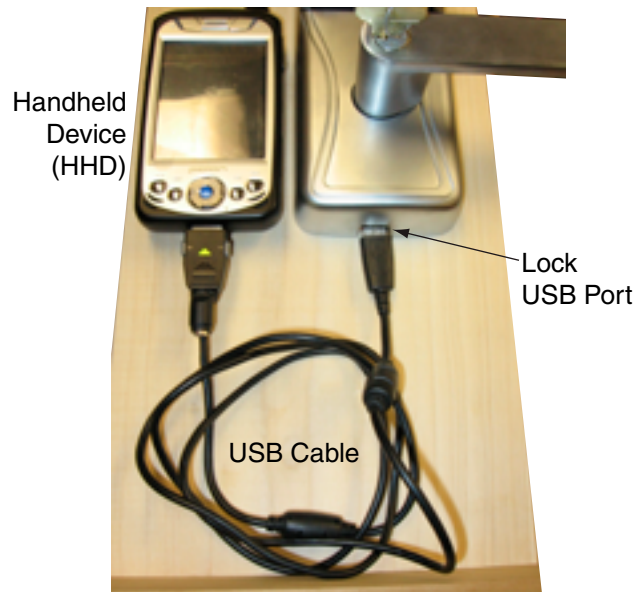

BM-150



BM-170

When communication is established, the device name will be displayed on the SUS main screen.

AD-Series Controllers

- 1 Start the Schlage Utility Software.
- 2 Make sure the HHD is in USB Connection Mode. See [Connection Type](#) on page 17 for more information.
- 3 Connect the USB cable to the HHD.
- 4 Plug the HHD USB cable into the controllers's USB port. Communication will begin automatically

When communication is established, the device name will be displayed on the SUS main screen.

Legacy CM and CL Locks (BM-150 with Serial Cable and CIP ONLY)

- 1 Start the Schlage Utility Software.
- 2 Make sure the HHD is in Serial Connection Mode. See [Connection Type](#) on page 17 for more information.
- 3 Connect the serial cable (HH-Serial) to the HHD and the CIP.
- 4 Connect the CIP to the legacy lock port.

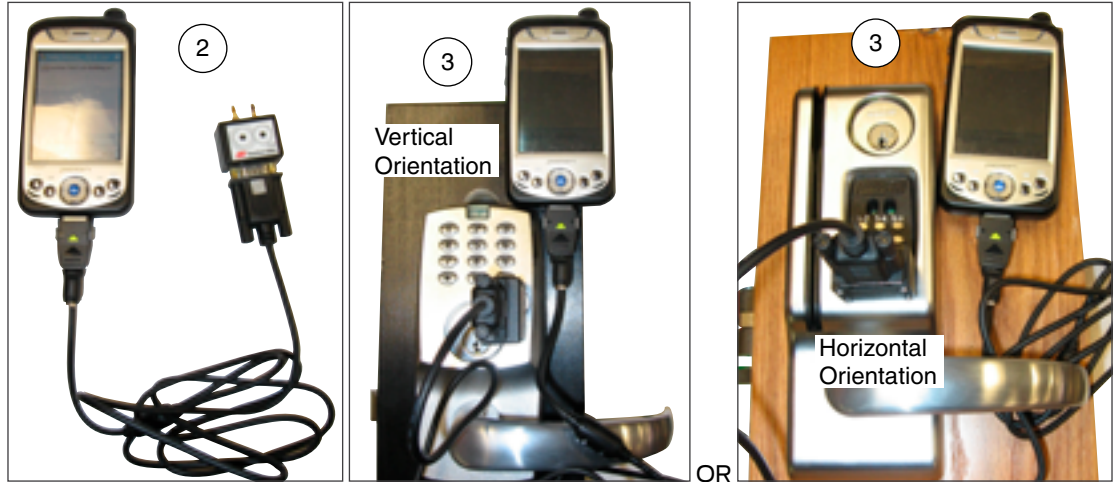

Legacy CM and CL Locks (BM-150 and BM-170 with 2PIN serial cable)

- 1 Start the Schlage Utility Software
- 2 Make sure the HHD is in Serial Connection Mode. See [Connection Type](#) on page 17 for more information.
- 3 Connect the 2PIN serial cable to the (HHD) and the Legacy lock port.



BM-150



BM-170

Legacy BE367 and FE210 Locks (BM-150 with Serial Cable and CIP ONLY)

- 1 Start the Schlage Utility Software.
- 2 Make sure the HHD is in Serial Connection Mode. See [Connection Type](#) on page 17 for more information.
- 3 The deadbolt must be retracted if this is the first time programming the lock.
- 4 Connect the serial cable (HH-Serial) to the HHD and the CIP.
- 5 Present the red programming iButton to the lock.
- 6 Connect the CIP to the lock port.
 - Rotate the thumbturn to the horizontal position, as shown, before connecting the CIP to the lock.

**Legacy BE367 and FE210 (BM-150 and BM-170 with 2PIN serial cable)**

- 1 Start the Schlage Utility Software
- 2 Make sure the HHD is in Serial Connection Mode. See [Connection Type](#) on page 17 for more information.
- 3 The deadbolt must be retracted if this is the first time programming the lock.
- 4 Present the Red programming iButton to the lock.
- 5 Connect the 2PIN serial cable to the (HHD) and the lock port.

**BM-150****BM-170**

Legacy PIM

- 1 Start the Schlage Utility Software.
- 2 Make sure the HHD is in Serial Connection Mode. See [Connection Type](#) on page 17 for more information.
- 3 Connect the serial cable (HH-Serial) to the HHD and the null modem adapter (PIMWA-CV).
- 4 Connect the null modem adapter to the legacy PIM serial port.
- 5 Simultaneously press the RESET and the LINK A buttons on the Legacy PIM, then release the RESET button while holding the LINK A button.
- 6 Continue holding the LINK A button (at least 15 seconds) until communication is established and the device name is displayed on the SUS main screen.



BM-150



BM-170



Legacy PIM

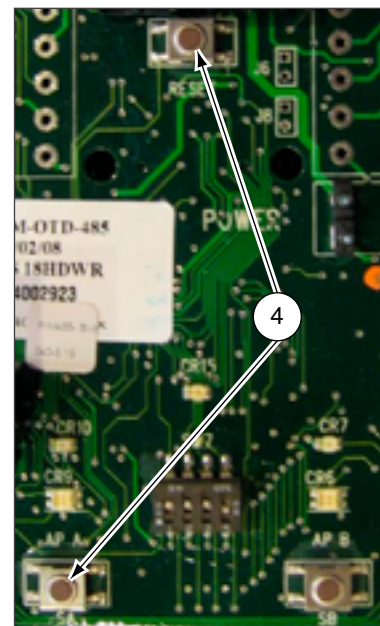

Legacy PIM

AD-Series Locks and Controllers

Supported Locks		Supported Controllers
All chassis for the following models are supported.		PIM400 (Panel Interface Module)
AD-Series Offline		WRI400 (Wireless Reader Interface)
AD-200	AD-250	WPR400 (Wireless Portable Reader)
AD-201		PIB300 (Panel Interface Board)
AD-Series Networked		CT5000 Controller
AD-300	AD-400	
AD-301	AD-401	
AD-302	AD-402	

This function works with AD-Series devices only.

The HHD will use a default Coupling Password (123456) when coupling with a device. The Coupling Password should be changed to provide increased security for your locks. See [Coupling Password](#) on page 18 for more information.

If a device is not in Coupling mode, SUS will display a device specific message with instructions for placing the device into Coupling mode.

Couple HHD to Lock

AD-Series locks can be coupled, or authenticated, with the HHD. This provides enhanced security by ensuring that the lock will only communicate with HHD(s) to which it has been coupled. Once the lock has been coupled, the Coupling Password is passed to the device from the HHD during programming.

- HHDs with the same coupling password can program the same devices. Once the HHD and lock are coupled, the coupling password is disabled in the lock and any HHD with the correct coupling password will automatically couple with the lock.
- 1 Connect the HHD to the lock using the HH-USB cable.
 - The HHD must be in USB mode. See [Connection Type](#) on page 17 for more information.
- 2 Press the Schlage button twice. The lock will be displayed on the screen.
- 3 On the HHD, select [Device Options](#).
- 4 Remove the top inside lock cover.
- 5 Press and hold the Inside Push button. Then press and release the tamper switch three times.
- 6 Release the Inside Push button. On the lock, the Inside Push button LED will illuminate.
- 7 On the HHD, select [Couple HHD to Device](#).
- 8 When Coupling is successful, a message will be displayed on the screen.

This function works with AD-Series devices only.

Couple HDD to PIM400 or PIB300

AD-Series devices can be coupled, or authenticated, with the HDD. This provides enhanced security by ensuring that the device will only communicate with HDD(s) to which it has been coupled. Once the device has been coupled, the coupling password is passed to the device from the HDD during programming.

The HDD will use a default Coupling Password (123456) when coupling with a device. The Coupling Password should be changed to provide increased security for your locks. See [Coupling Password](#) on page 18 for more information.

If a device is not in Coupling mode, SUS will display a device specific message with instructions for placing the device into Coupling mode.

→ HDDs with the same coupling password can program the same devices. Once the HDD and the device are coupled, the coupling password is disabled in the PIM400 or PIB300 and any HDD with the correct coupling password will automatically couple with the PIM400 (or PIB300).

- 1 Remove the PIM400 or PIB300 cover.
- 2 The HDD must be in USB mode. See [Connection Type](#) on page 17 for more information.
- 3 Connect the HDD to the PIM400 or PIB300 using the HH-USB cable. The PIM400 or PIB300 will be displayed on the HDD screen.
- 4 On the HDD, select [Device Options](#).
- 5 On the PIM400 or PIB300, press and hold the LINK 1 button. Then press the LINK 2 button three times.
- 6 On the HDD, select [Couple HDD to Device](#).
- 7 When Coupling is successful, a message will be displayed on the HDD screen.

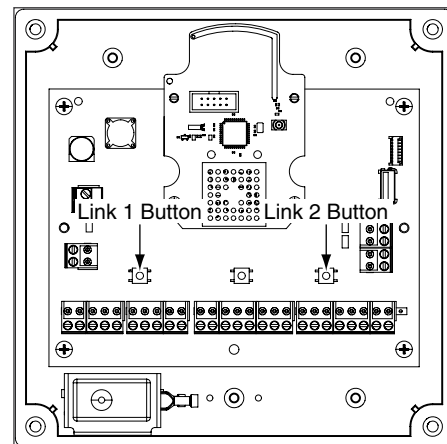

This function works with AD-Series devices only.

Couple HDD to WRI400/CT5000

The WRI400/CT5000 can be coupled, or authenticated, with the HDD. This provides enhanced security by ensuring that the device will only communicate with HDD(s) to which it has been coupled. Once the device has been coupled, the programming password is passed to the device from the HDD during programming.

The HDD will use a default Coupling Password (123456) when coupling with a device. The Coupling Password should be changed to provide increased security for your locks. See [Coupling Password](#) on page 18 for more information.

If a device is not in Coupling mode, SUS will display a device specific message with instructions for placing the device into Coupling mode.

→ HDDs with the same programming password can program the same devices. Once the HDD and the device are coupled, the coupling password is disabled in the WRI400/CT5000 and any HDD with the correct coupling password will automatically couple with the WRI400/CT5000.

- 1 Remove the device cover.
- 2 The HDD must be in USB mode. See [Connection Type](#) on page 17 for more information.
- 3 Connect the HDD to the device using the HH-USB cable. The name of the device will be displayed on the HDD screen.
- 4 On the HDD, select [Device Options](#).
- 5 On the WRI400/CT5000, press and hold the Schlage button. Then press the LINK button three times within five (5) seconds. Then release both buttons.
- 6 On the HDD, select [Couple HDD to Device](#).
- 7 When Coupling is successful, a message will be displayed on the HDD screen.

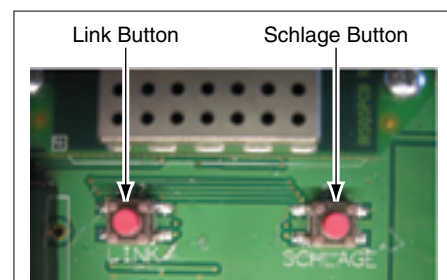

Program a Lock or Controller

Offline Locks

- 1 Connect the HHD to the lock or controller and establish communication between the HHD and the device.
- 2 Select **Device Options**.
- 3 Select **Program Lock**.
- 4 Select the door file that should be associated with the lock or controller.
 - Door files are downloaded to the HHD when synchronized with the access control software.
- 5 Select **OK**.

Online Locks

- NOTE: This function is not applicable to online locks.

Collect Audits and Update Lock

Collecting audits on the HHD does not delete the audits from a lock.

Collected audits will be transferred from HHD to your Access Control Software the next time they are synchronized.

When Auto Update is enabled, as soon as the Schlage button is pressed twice and the communication with the Schlage Utility Software starts, the lock will automatically:

- update lock's date/time
- collect audits
- update access rights

When Manual Update is enabled, follow the steps below to collect audits and update the lock access rights.

- See **Update Mode** on page 18 for more information.

Collect Audits when Date/Time and Lock Access Rights are Up-to-Date

- 1 Confirm HHD is connected to lock.
 - See **Connecting the Handheld Device** on page 20 for more information.
- 2 Double-click the displayed name of the connected lock.
- 3 The audit collection will begin.
 - If no previous audit exists, skip to step 7.
- 4 If a previous audit exists, a message will appear asking to overwrite previous audit. Click **YES** to override audits and skip to step 7.
- 5 Click **NO** if you do not want to override the audit.
- 6 Acknowledge the message advising to synchronize the lock with system software. Audit collection will be stopped.
- 7 A progress indicator will be displayed while the audit is being collected. A message will be displayed once the process is complete.

Collect Audits when Date/Time and Lock Access Rights are Not Up-to-Date

- 1 Confirm HHD is connected to lock.
→ See [Connecting the Handheld Device](#) on page 20 for more information.
- 2 Double-click the displayed name of the connected lock.
- 3 When asked to update date and time of the device, click **YES**. A progress indicator will be displayed while date and time is being updated.
- 4 A message will appear to confirm the successful update.
- 5 The audit collection will begin. A progress indicator will be displayed while the audit is being collected.
- 6 The access rights update will begin. A progress indicator will be displayed while lock is being updated.
- 7 A message will be displayed once the process is complete.

View Properties

- 1 Connect the HHD to the lock or controller.
- 2 Select [Device Options](#).
- 3 Select [Properties](#) for the connected device.
- 4 The [View](#) tab will be displayed.
→ See [Lock Properties](#) on page 31 for more information.

Edit Properties

- 1 Connect the HHD to the device.
 - 2 Select [Device Options](#).
 - 3 Select [Properties](#) for the connected device.
 - 4 Select the [Edit](#) tab.
 - 5 Edit the properties as desired.
→ See [Lock Properties](#) on page 31 for more information.
 - 6 Select [Save](#) to update and save the changes.
- 1 Connect the HHD to the device.
 - 2 Select [Device Options](#).
 - 3 Select [Properties](#) for the connected device.
 - 4 Select the [Reader](#) tab.
→ See [Lock Properties](#) on page 31 for more information.

Edit Reader Properties

- 1 Connect the HHD to the device.
- 2 Select [Device Options](#).
- 3 Select [Properties](#) for the connected device.
- 4 Select the [Reader](#) tab.
- 5 Edit the properties as desired.
- 6 Select [Save](#) to update and save the changes.
→ See [Lock Properties](#) on page 31 for more information.

Put PIM400 into Link Mode

- 1 Connect the HHD to the PIM400.
- 2 Select **Device Options**.
- 3 Select **PIM Properties** for the connected device.
- 4 Select the **Link** tab.
- 5 Select the door number from the drop-down box.
 - See the system administrator for the proper door number selection.
- 6 The PIM400 will stay in link mode for up to 30 minutes.
- 7 Put the lock (door) into link mode.
 - See the user guide that came with the lock for more information.
- 8 The PIM400 will automatically exit link mode once linking is complete.

Put PIM400 into Diagnostics Mode

- 1 Connect the HHD to the PIM400 and select Device Options.
- 2 Select Diagnostics and then select the door number from the drop-down box.
 - Card Data box: shows card data from credential when card presented to reader.
 - Unlock on Read: if enabled allows the door to be unlocked upon the reading of a card: the OEM has the ability to disable this feature (grayed out).

Update Firmware

- See **AD-Series and CO-Series Device Firmware Update** on page **77** for more information.

Diagnostic Data Log Feature

This new feature provides a simple method for AD-Series customers to quickly gather and save important lock-status information in a file. For details see Appendix E: Diagnostic Data Log.

AD-Series Readers

The Multi-Tech and Multi-Tech + Keypad readers will read both proximity and smart cards. The Proximity, Proximity + Keypad ONLY and Smart Card, Smart Card + Keypad ONLY readers have been discontinued and replaced by the MultiTech, Multi-Tech + Keypad readers that provide all the same functionality as the original Proximity and Smart card readers in a single credential reader.



Multi-Tech

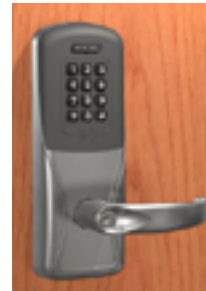

Multi-Tech + Keypad

The MiK and SiK2 readers are both a solution for applications using the HID iClass smart card credential.

iCLASS® is a proprietary smart card technology developed by HID that operates on ISO 15693. In order to support these requirements, iClass + Multi-Tech + Keypad reader were integrated to create the (MiK) and (SiK2). (SiK2) is not capable of reading Proximity credentials.



iClass + Multi-Tech

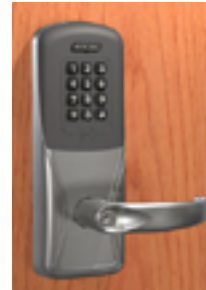

iClass + Multi-Tech + Keypad

The FMK reader module is for applications which require approval by the U.S. Federal Government under HSPD-12 for FIPS 201 compliance. In order to meet these requirements, FIPS + Multi-Technology + Keypad reader were integrated to create the (FMK).

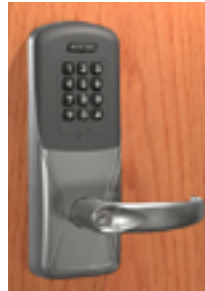

FIPS + Multi-Tech + Keypad



MagInsert



MagInsert + Keypad



MagSwipe

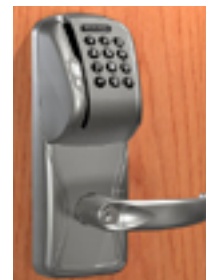

MagSwipe + Keypad

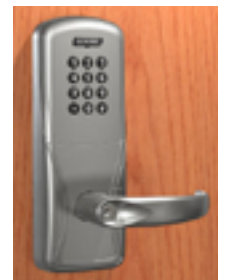

Keypad

Reader Types	
Reader Description	Reader Type Shown in SUS
Mag Insert with Keypad	MagInsert + Keypad
Mag Insert without Keypad	MagInsert
Mag Swipe with Keypad	MagSwipe + Keypad
Mag Swipe without Keypad	MagSwipe
Keypad Only	Keypad
Prox with Keypad	Proximity + Keypad
Prox without Keypad	Proximity
Smart with Keypad	Smart Card + Keypad
Smart without Keypad	Smart Card
FMK Reader	FIPS + Multi-Tech + Keypad
MT	Multi-Tech
MTK	Multi-Tech + Keypad
Mi	iClass + Multi-Tech
MiK	iClass + Multi-Tech + Keypad
MT2	Multi-Tech 2
MTK2	Multi-Tech 2 + Keypad
FMK2	FIPS + Multi-Tech 2 + Keypad
KP2	Keypad 2
Si2	iClass + Smart Only 2
SiK2	iClass + Smart Only 2 + Keypad

- Note: (Multi-Tech, Multi-Tech + Keypad) and (iClass + Multi-Tech, iClass + Multi-Tech + Keypad) and (FIPS + Multi-Tech + Keypad) and (Keypad) readers are being discontinued (1st half 2016) and replaced by the (Multi-Tech 2, Multi-Tech + Keypad 2) and (FIPS + Multi-Tech + Keypad 2) and (Keypad 2) readers that provide all the same functionality as the original readers.

Lock Properties

- AD-200/250 (Offline Locks): pg 31
- AD-300/AD-301/AD-302 (Networked Locks): pg 34
- AD-400/AD-401/AD-402 (Networked Locks): pg 38

AD-200/250 (Offline Locks)

Property	Description
Date & Time	Current date and time. Initialized/set by the HHD.
General Properties	
Lock Name	The name of the Lock. Set by the door file programmed into the lock.
Model	Model number of the device connected to the HHD.
Max Users	Number of Users supported by the lock (AD-200).
Max Void List	Number of void users supported by the lock (AD-250).
Power Status	Current voltage level of the AA and Coin Cell batteries. Number of AA batteries connected to the lock.
Max One Time User	Number of one time use PIN codes supported by the lock (AD-250).
Main Lock	
Serial Number	Serial number that uniquely identifies the lock.
Manufacture Date	Date the lock was manufactured.
Days Since Installed	Used for warranty purposes; it marks the beginning of the lock's functional life.
Firmware Version	Version of the current firmware file. Automatically updated when a new firmware version is loaded.
Hardware Version	Current version of the printed circuit main board.
Bootloader Version	Version of the current bootloader. Allows new firmware to be loaded.
Credential Reader	
Serial Number	Serial number that uniquely identifies the reader.
Manufacture Date	Date the reader was manufactured.
Firmware Version	Version of the current firmware file. Automatically updated when a new firmware version is loaded.
Hardware Version	Current version of the printed circuit credential board.
Bootloader Version	Version of the current bootloader. Allows new firmware to be loaded.
Reader Type	Type of Reader installed: <ul style="list-style-type: none"> • MagInsert • MagInsert + Keypad • MagSwipe • MagSwipe + Keypad • Keypad • Proximity • Proximity + Keypad • Smart Card • Smart Card + Keypad • Multi-Tech • Multi-Tech + Keypad • FIPS + Multi-Tech + Keypad • iClass + Multi-Tech • iClass + Multi-Tech + Keypad • Multi-Tech 2 • Multi-Tech 2 + Keypad • FIPS + Multi-Tech 2 + Keypad • Keypad 2 • iClass + Smart Only 2 • iClass + Smart Only 2 + Keypad
Custom Key	If the reader supports reporting the status of custom configuration then SUS displays "Custom Key: Installed" or "Custom Key: Not Installed"

VIEW Tab

AD-200/250 (Offline Locks)

	Property	Description	Default
EDIT Tab	Lock Type	<p>Classroom: Unlocks when a credential is presented and then automatically locks after the relock delay has expired.</p> <p>Office: Unlocks when a credential is presented and then automatically locks after the relock delay has expired. To keep the door unlocked, push the button on the inside. The button will momentarily illuminate green. To return the lock to the locked state, push the button again or present a credential to the outside.</p> <p>Privacy: To initiate the Privacy function, with the door closed, push the button on the inside of the door. This prevents normal credentials from opening the door from the outside.</p> <p>The lock will go back to its normal state when the button is pushed again or when the door position switch indicates that the door has opened.</p> <p>When using a Mortise Deadbolt, extending the deadbolt from the inside lights a red LED on the inside trim and initiates the Privacy function which prevents normal credentials from opening the door from the outside. The lock can always be opened using a Pass-Through credential or mechanical key in case of emergency.</p> <p>Apartment: The apartment function lock is normally locked and never relocks automatically, which prevents users from being locked out.</p> <p>To unlock the door from the outside, present a credential.</p> <p>To unlock the door from the inside, push the inside button or, if using the MD chassis, retract the deadbolt. Egress always available from inside.</p> <p>When lever is rotated and door is opened, the request-to-exit switch is used in conjunction with the door position switch to cause the door to return to unlocked condition.</p> <p>To lock the door from the outside, present a credential.</p> <p>To lock the door from the inside, push the inside button or, for MD chassis, extend the deadbolt.</p>	Set by the Factory
	PIN Length (AD-200 only)	Maximum number of digits in the user PIN. Range of 3 to 6 digits.	6
	Allow Privacy Mode Override (AD-250 only)	When enabled, allows cards to override a lock that has been placed in privacy mode. When disabled, only cards specifically assigned to this door will have access.	Disabled
	Ignore Keypad	If checked, key entry codes are ignored.	Disabled
	Record Lock/Unlock	If checked and supported by the system software, will record an audit event when the Inside Push button is pressed.	Disabled
	Enable/Disable Interior LED Status Blinking	<p>Enables or Disables the interior LED's status blinking.</p> <p>When enabled: (enables two options to be checked)</p> <ul style="list-style-type: none"> • Blink Interior Button LED when locked - The IPB will flash every 15 seconds for the first 10 minutes; it will then flash every 30 seconds for the next 50 minutes; and it will then flash every minute after 1 hour. If a door actuation occurs, then the process is restarted. • Blink Interior LED Rapidly when in Privacy Mode - Interior LED will flash rapidly while privacy mode is enabled. 	Disabled (unchecked)
	Battery Fail Mode	Lock state set when battery fails. As-Is, Secure/Locked, Unsecure/Unlocked	As-Is
	Relock Delay	Amount of time before the lock relocks after being unlocked by a user presenting a valid credential.	3
	ADA Delay	Amount of time before the lock relocks after being unlocked by a user who is flagged as handicapped and presenting a valid credential. Can be changed in the access control system.	30
	Offline Lockdown Mode	This configuration is only applicable for AD200. If checked, lockdown mode is enabled on the lock.	disabled

AD-200/250 (Offline Locks)

Property	Description	Default																																
Prox in Use (AD-200 only)	Proximity credential card types allowed. Selections: <ul style="list-style-type: none"> • HID/Kantech • ioProx* • GE/CASI • GE4001 • GE4002* • AWID* 	* Default formats																																
Mag Track in Use	Magnetic card track that access data is to be read from. Track 1, 2 or 3. Track 1 not configurable for AD-200.	Track 2																																
Enable Low Power Wake-Up	Active when Mag Track 1 or 3 is selected in "Mag Track in Use". By enabling Low Power Wake-Up and recording data on track 2, this option will allow longer battery life.	Enabled																																
Smart Cards in Use (AD-200 only)	Smart card(s) to be used with the card reader. <ul style="list-style-type: none"> • 14443 UID(CSN) (when selected, disables all other 14443 selections and PIV format) • 14443 Secure MiFare Classic* • 14443 Secure MiFare Plus* • 14443 EV1 (NOC)* • 15693 UID (CSN)* <p>MTK1</p> <ul style="list-style-type: none"> • iClass credential formats for Reader Types which support Smart Cards <ul style="list-style-type: none"> • iClass 40-bit UID (CSN) • iClass 64-bit UID (CSN)* • HID iClass Classic* (only appears with Mi/MiK reader attached) • PIV credential formats for AD200 reader types which support Smart Cards. Range is 1 to 15. <table style="width: 100%; border: none;"> <tr> <td style="width: 50%;">1. 75 Bit PIV*</td> <td style="width: 50%;">8. 91 Bit (83 Bit Format + TSM)</td> </tr> <tr> <td>2. 58 Bit TWIC/CAC</td> <td>9. 40 Bit BCD</td> </tr> <tr> <td>3. 200 Bit FASC-N</td> <td>10. 40 Bit Reversed BCD</td> </tr> <tr> <td>4. 64 Bit (BCD) TWIC/CAC</td> <td>11. 64 Bit BCD</td> </tr> <tr> <td>5. 83 Bit TWIC/CAC</td> <td>12. 64 Bit Reversed BCD</td> </tr> <tr> <td>6. 66 Bit (58 Bit Format + TSM) TWIC/CAC</td> <td>13. 128 Bit BCD</td> </tr> <tr> <td>7. 64 Bit (58 Bit Format (no parity) + TSM) TWIC/CAC</td> <td>14. 128 Bit Reversed BCD</td> </tr> <tr> <td></td> <td>15. 58 Bit HSE</td> </tr> </table> <p>MTK2</p> <ul style="list-style-type: none"> • iClass/Felica credential formats for Reader Types which support Smart Cards <ul style="list-style-type: none"> • iClass/Felica 40-bit UID (CSN) • iClass/Felica 64-bit UID (CSN)* • HID iClass/iClass SE/iClass SEOS (only appears with Si2/SiK2 reader attached). Enabled by default. • PIV credential formats for AD200 reader types which support Smart Cards. Range is 1 to 15. <table style="width: 100%; border: none;"> <tr> <td style="width: 50%;">1. 75 Bit PIV*</td> <td style="width: 50%;">8. 91 Bit (83 Bit Format + TSM)</td> </tr> <tr> <td>2. 58 Bit TWIC/CAC</td> <td>9. 40 Bit BCD</td> </tr> <tr> <td>3. 200 Bit FASC-N</td> <td>10. 40 Bit Reversed BCD</td> </tr> <tr> <td>4. 64 Bit (BCD) TWIC/CAC</td> <td>11. 64 Bit BCD</td> </tr> <tr> <td>5. 83 Bit TWIC/CAC</td> <td>12. 64 Bit Reversed BCD</td> </tr> <tr> <td>6. 66 Bit (58 Bit Format + TSM) TWIC/CAC</td> <td>13. 128 Bit BCD</td> </tr> <tr> <td>7. 64 Bit (58 Bit Format (no parity) + TSM) TWIC/CAC</td> <td>14. 128 Bit Reversed BCD</td> </tr> <tr> <td></td> <td>15. 58 Bit HSE</td> </tr> </table> 	1. 75 Bit PIV*	8. 91 Bit (83 Bit Format + TSM)	2. 58 Bit TWIC/CAC	9. 40 Bit BCD	3. 200 Bit FASC-N	10. 40 Bit Reversed BCD	4. 64 Bit (BCD) TWIC/CAC	11. 64 Bit BCD	5. 83 Bit TWIC/CAC	12. 64 Bit Reversed BCD	6. 66 Bit (58 Bit Format + TSM) TWIC/CAC	13. 128 Bit BCD	7. 64 Bit (58 Bit Format (no parity) + TSM) TWIC/CAC	14. 128 Bit Reversed BCD		15. 58 Bit HSE	1. 75 Bit PIV*	8. 91 Bit (83 Bit Format + TSM)	2. 58 Bit TWIC/CAC	9. 40 Bit BCD	3. 200 Bit FASC-N	10. 40 Bit Reversed BCD	4. 64 Bit (BCD) TWIC/CAC	11. 64 Bit BCD	5. 83 Bit TWIC/CAC	12. 64 Bit Reversed BCD	6. 66 Bit (58 Bit Format + TSM) TWIC/CAC	13. 128 Bit BCD	7. 64 Bit (58 Bit Format (no parity) + TSM) TWIC/CAC	14. 128 Bit Reversed BCD		15. 58 Bit HSE	* Default formats
1. 75 Bit PIV*	8. 91 Bit (83 Bit Format + TSM)																																	
2. 58 Bit TWIC/CAC	9. 40 Bit BCD																																	
3. 200 Bit FASC-N	10. 40 Bit Reversed BCD																																	
4. 64 Bit (BCD) TWIC/CAC	11. 64 Bit BCD																																	
5. 83 Bit TWIC/CAC	12. 64 Bit Reversed BCD																																	
6. 66 Bit (58 Bit Format + TSM) TWIC/CAC	13. 128 Bit BCD																																	
7. 64 Bit (58 Bit Format (no parity) + TSM) TWIC/CAC	14. 128 Bit Reversed BCD																																	
	15. 58 Bit HSE																																	
1. 75 Bit PIV*	8. 91 Bit (83 Bit Format + TSM)																																	
2. 58 Bit TWIC/CAC	9. 40 Bit BCD																																	
3. 200 Bit FASC-N	10. 40 Bit Reversed BCD																																	
4. 64 Bit (BCD) TWIC/CAC	11. 64 Bit BCD																																	
5. 83 Bit TWIC/CAC	12. 64 Bit Reversed BCD																																	
6. 66 Bit (58 Bit Format + TSM) TWIC/CAC	13. 128 Bit BCD																																	
7. 64 Bit (58 Bit Format (no parity) + TSM) TWIC/CAC	14. 128 Bit Reversed BCD																																	
	15. 58 Bit HSE																																	
Beeper	Indicates if the Beeper is on or off.	ON																																

READER Tab

AD-300/AD-301/AD-302 (Networked Locks)

Property	Description
General Properties	
Model	Model number of the device connected to the HHD.
Power Status	Shows current auxiliary power status of OFF/ON.
FIPS201-2 Capable (AD-302 only)	The Yes or No value for this field indicates whether the device (i.e. Lock/Reader combination) is FIPS201-2 Capable or not.
Main Lock	
RS485 Partner ID	Identifies the participating OEM software partner.
Serial Number	Serial number that uniquely identifies the lock.
Manufacture Date	Date the lock was manufactured.
Days Since Installed	Used for warranty purposes; it marks the beginning of the lock's functional life.
Firmware Version	Version of the current firmware file. Automatically updated when new firmware file is loaded.
Hardware Version	Current version of the printed circuit main board.
Bootloader Version	Version of the current bootloader. Allows new firmware to be loaded.
Credential Reader	
Serial Number	Serial number that uniquely identifies the reader.
Manufacture Date	Date the reader was manufactured
Firmware Version	Version of the current firmware file. Automatically updated when new firmware file is loaded.
Hardware Version	Current version of the printed circuit main board.
Bootloader Version	Version of the current bootloader. Allows new firmware to be loaded.
Reader Type	Type of Reader installed: <ul style="list-style-type: none"> • MagInsert • MagInsert + Keypad • MagSwipe • MagSwipe + Keypad • Keypad • Proximity • Proximity + Keypad • Smart Card • Smart Card + Keypad • Multi-Tech • Multi-Tech + Keypad • FIPS + Multi-Tech + Keypad • iClass + Multi-Tech • iClass + Multi-Tech + Keypad • Multi-Tech 2 • Multi-Tech 2 + Keypad • FIPS + Multi-Tech 2 + Keypad • Keypad 2 • iClass + Smart Only 2 • iClass + Smart Only 2 + Keypad
Custom Key	If the reader supports reporting the status of custom configuration then SUS displays "Custom Key: Installed" or "Custom Key: Not Installed"

VIEW Tab

AD-300/AD-301/AD-302 (Networked Locks)

	Property	Description	Default
EDIT Tab	RS485 Address	Set the RS-485 network address of the lock. 0-255	0
	ACP Timeout	Time (in seconds) to wait before determining communication from the ACP has failed.	3 seconds
	Comm Loss Fail Mode	Lock state set when communication from the ACP fails. As-Is, Secure/Locked, Unsecure/Unlocked	As-Is
	Power Fail Mode	Lock state set when power to the lock fails. As-Is, Secure/Locked, Unsecure/Unlocked	As-Is
	Degraded (Cache) Mode: Card Bit Format*	Enter the number of bits on the cards being used to enable degraded mode. abilities. 0 = cache mode disabled	0
	Degraded (Cache) Mode: Full Card Number or Facility Code*	Use the full card number or the facility codes of previously approved credentials in the Degraded (Cache) mode. Granting access is determined by "Full Card" content or just "Facility Code".	Full Card
	Degraded (Cache) Mode: Purge unused after 5 days*	When enabled, deletes the cache entry after 5 days of non-use. If enabled, cards that have not accessed the lock within 5 days will be removed.	Disabled
	Degraded (Cache) Mode: Clear Cache*	Deletes all valid user credentials from the Degraded (cache) memory. Allows you to manually clear cache memory.	n/a
	Max Entries Stored*	Number of credential cards or facility codes maintained in the cache. Minimum of 5, Maximum of 1000.	125
	Disable Interior Button LED	If checked, interior button LED blinking is disabled.	LED is Enabled (unchecked)
	Relock Delay	Amount of time before the lock relocks after being unlocked by a user presenting a valid credential.	3 seconds
	Relatch After: Timer/Door Status	Re-latch on: <ul style="list-style-type: none"> Timer Only (Lock when timer expires regardless of Door status or Position) On Door Open or Timer (Lock when the Door opens or Timer expires) On Door Close or Timer (Lock when the Door closes or Timer expires) 	Timer only
	Card + PIN LED mode	Disabled Mode 1: 2 alternating blinks Mode 2: Solid Green/2 red blinks	1
	Communication Link	Direct to Host: Sets RS-485 communication protocol to work directly with an ACP. Through PIB300: Sets RS-485 communication protocol through the PIB300.	Direct to Host
FIPS201-2 Authentication	This checkbox will allow the user to choose whether to perform the full FIPS201-2 authentication for PIV credentials. Also, since this operation is not applicable on all lock types, it appears Grayed out (un-editable) for the following lock types: AD-300, AD-301.	unchecked	

* AD-302 does not support Cache mode; these options will be grayed out.

AD-300/AD-301/AD-302 (Networked Locks)

Property	Description	Default				
Prox in Use	Proximity credential card types allowed. Selections: <ul style="list-style-type: none"> • HID/Kantech • GE/CASI • AWID* • ioProx* • GE4001 • GE4002* 	* Default formats				
Mag Track in Use	Magnetic card track that access data is to be read from. Track 1, 2 or 3	Track 2				
Enable Low Power Wake-Up	Active when Mag Track 1 or 3 is selected in "Mag Track in Use". By enabling Low Power Wake-Up and having data on track 2, this option will allow longer battery life. (Available only on battery-powered locks.)	Enabled				
Smart Cards in Use	Smart card(s) to be used with the card reader. <ul style="list-style-type: none"> • 14443 UID(CSN) (when selected, disables all other 14443 selections and PIV format) • 14443 Secure MiFare Classic* • 14443 Secure MiFare Plus* • 14443 EV1 (NOC)* • 15693 UID (CSN)* <p>MTK1</p> <ul style="list-style-type: none"> • iClass credential formats for Reader Types which support Smart Cards <ul style="list-style-type: none"> • iClass 40-bit UID (CSN) • iClass 64-bit UID (CSN)* • HID iClass Classic* (only appears with Mi/MiK reader attached) • PIV credential formats for AD200 reader types which support Smart Cards. Range is 1 to 15. <table style="width: 100%; border: none;"> <tr> <td style="width: 50%; vertical-align: top;"> <ol style="list-style-type: none"> 1. 75 Bit PIV* 2. 58 Bit TWIC/CAC 3. 200 Bit FASC-N 4. 64 Bit (BCD) TWIC/CAC 5. 83 Bit TWIC/CAC 6. 66 Bit (58 Bit Format + TSM) TWIC/CAC 7. 64 Bit (58 Bit Format (no parity) + TSM) TWIC/CAC </td> <td style="width: 50%; vertical-align: top;"> <ol style="list-style-type: none"> 8. 91 Bit (83 Bit Format + TSM) TWIC/CAC 9. 40 Bit BCD 10. 40 Bit Reversed BCD 11. 64 Bit BCD 12. 64 Bit Reversed BCD 13. 128 Bit BCD 14. 128 Bit Reversed BCD 15. 58 Bit HSE </td> </tr> </table> <p>MTK2</p> <ul style="list-style-type: none"> • iClass/Felica credential formats for Reader Types which support Smart Cards <ul style="list-style-type: none"> • iClass/Felica 40-bit UID (CSN) • iClass/Felica 64-bit UID (CSN)* • HID iClass/iClass SE/iClass SEOS (only appears with Si2/SiK2 reader attached). Enabled by default. • PIV credential formats for AD200 reader types which support Smart Cards. Range is 1 to 15. <table style="width: 100%; border: none;"> <tr> <td style="width: 50%; vertical-align: top;"> <ol style="list-style-type: none"> 1. 75 Bit PIV* 2. 58 Bit TWIC/CAC 3. 200 Bit FASC-N 4. 64 Bit (BCD) TWIC/CAC 5. 83 Bit TWIC/CAC 6. 66 Bit (58 Bit Format + TSM) TWIC/CAC 7. 64 Bit (58 Bit Format (no parity) + TSM) TWIC/CAC </td> <td style="width: 50%; vertical-align: top;"> <ol style="list-style-type: none"> 8. 91 Bit (83 Bit Format + TSM) TWIC/CAC 9. 40 Bit BCD 10. 40 Bit Reversed BCD 11. 64 Bit BCD 12. 64 Bit Reversed BCD 13. 128 Bit BCD 14. 128 Bit Reversed BCD 15. 58 Bit HSE </td> </tr> </table> 	<ol style="list-style-type: none"> 1. 75 Bit PIV* 2. 58 Bit TWIC/CAC 3. 200 Bit FASC-N 4. 64 Bit (BCD) TWIC/CAC 5. 83 Bit TWIC/CAC 6. 66 Bit (58 Bit Format + TSM) TWIC/CAC 7. 64 Bit (58 Bit Format (no parity) + TSM) TWIC/CAC 	<ol style="list-style-type: none"> 8. 91 Bit (83 Bit Format + TSM) TWIC/CAC 9. 40 Bit BCD 10. 40 Bit Reversed BCD 11. 64 Bit BCD 12. 64 Bit Reversed BCD 13. 128 Bit BCD 14. 128 Bit Reversed BCD 15. 58 Bit HSE 	<ol style="list-style-type: none"> 1. 75 Bit PIV* 2. 58 Bit TWIC/CAC 3. 200 Bit FASC-N 4. 64 Bit (BCD) TWIC/CAC 5. 83 Bit TWIC/CAC 6. 66 Bit (58 Bit Format + TSM) TWIC/CAC 7. 64 Bit (58 Bit Format (no parity) + TSM) TWIC/CAC 	<ol style="list-style-type: none"> 8. 91 Bit (83 Bit Format + TSM) TWIC/CAC 9. 40 Bit BCD 10. 40 Bit Reversed BCD 11. 64 Bit BCD 12. 64 Bit Reversed BCD 13. 128 Bit BCD 14. 128 Bit Reversed BCD 15. 58 Bit HSE 	* Default formats
<ol style="list-style-type: none"> 1. 75 Bit PIV* 2. 58 Bit TWIC/CAC 3. 200 Bit FASC-N 4. 64 Bit (BCD) TWIC/CAC 5. 83 Bit TWIC/CAC 6. 66 Bit (58 Bit Format + TSM) TWIC/CAC 7. 64 Bit (58 Bit Format (no parity) + TSM) TWIC/CAC 	<ol style="list-style-type: none"> 8. 91 Bit (83 Bit Format + TSM) TWIC/CAC 9. 40 Bit BCD 10. 40 Bit Reversed BCD 11. 64 Bit BCD 12. 64 Bit Reversed BCD 13. 128 Bit BCD 14. 128 Bit Reversed BCD 15. 58 Bit HSE 					
<ol style="list-style-type: none"> 1. 75 Bit PIV* 2. 58 Bit TWIC/CAC 3. 200 Bit FASC-N 4. 64 Bit (BCD) TWIC/CAC 5. 83 Bit TWIC/CAC 6. 66 Bit (58 Bit Format + TSM) TWIC/CAC 7. 64 Bit (58 Bit Format (no parity) + TSM) TWIC/CAC 	<ol style="list-style-type: none"> 8. 91 Bit (83 Bit Format + TSM) TWIC/CAC 9. 40 Bit BCD 10. 40 Bit Reversed BCD 11. 64 Bit BCD 12. 64 Bit Reversed BCD 13. 128 Bit BCD 14. 128 Bit Reversed BCD 15. 58 Bit HSE 					

READER Tab

AD-300/AD-301/AD-302 (Networked Locks)

READER Tab	Beeper	Indicates if the Beeper is On or Off.	ON
	Keypad: Output Type	Wiegand or Magnetic output type.	Wiegand
	Keypad: Facility Code	A facility or site code is encoded into each card to increase security. A number from 0 to 255 on a 26-bit format card.	1
	Keypad: Keys Buffered	Fixed number of key presses to buffer. Range in 1 to 11. Active only in keypad output modes that support buffered key presses. See Output formats 4, 6, 9 and 10 below.	4
	Keypad: Output Format	Sets the keypad data length and format mode. Range is 0 to 12. 0. Disable Keypad output 1. Mode 1: 4 Data Bits per Key without Parity (high nibble) 2. Mode 2: 4 Data Bits per Key with Parity 3. Mode 3: 8 Data Bits per Key without Parity 4. Mode 4: 8 Data Bits per Key with Parity 5. Mode 5: 4 Data Bits per Key, Buffered Key Presses without Parity 6. Mode 6: 4 Data Bits per Key, Buffered Key Presses with Parity 7. Mode 7: 26 Bit Wiegand Emulation 8. Mode 8: 4 Data Bits per Key without Parity (low nibble) 9. Mode 9: IR, 4 Data Bits per Key, Buffered Key Presses without Parity 10. Mode 10: IR, 4 Data Bits per Key, Buffered Key Presses with Parity 11. Mode 11: 8 Data Bits per Key, ASCII with parity 12. Mode 12: 32 Bit Wiegand Emulation	1

AD-400/AD-401/AD-402 (Networked Locks)

Property	Description
General Properties	
Model	Model number of the device connected to the HHD.
Power Status	Current voltage level and number of AA batteries.
FIPS201-2 Capable (AD-402 only)	The Yes or No value for this field indicates whether the device (i.e. Lock/Reader combination) is FIPS201-2 Capable or not.
Main Lock	
RS485 Partner ID	Identifies the participating OEM software partner.
Serial Number	Serial number that uniquely identifies the lock.
Manufacture Date	Date the lock was manufactured.
Days Since Installed	Used for warranty purposes; it marks the beginning of the lock's functional life.
Firmware Version	Version of the current firmware file. Automatically updated when new firmware file is loaded.
Hardware Version	Current version of the printed circuit main board.
Bootloader Version	Version of the current bootloader. Allows new firmware to be loaded.
Credential Reader	
Serial Number	Serial number that uniquely identifies the reader.
Manufacture Date	Date the reader was manufactured.
Firmware Version	Version of the current firmware file. Automatically updated when new firmware file is loaded.
Hardware Version	Current version of the printed circuit credential board.
Bootloader Version	Version of the current bootloader. Allows new firmware to be loaded.
Reader Type	Type of Reader installed: <ul style="list-style-type: none"> • MagInsert • MagInsert + Keypad • MagSwipe • MagSwipe + Keypad • Keypad • Proximity • Proximity + Keypad • Smart Card • Smart Card + Keypad • Multi-Tech • Multi-Tech + Keypad • FIPS + Multi-Tech + Keypad • iClass + Multi-Tech • iClass + Multi-Tech + Keypad • Multi-Tech 2 • Multi-Tech 2 + Keypad • FIPS + Multi-Tech 2 + Keypad • Keypad 2 • iClass + Smart Only 2 • iClass + Smart Only 2 + Keypad
Custom Key	If the reader supports reporting the status of custom configuration then SUS displays "Custom Key: Installed" or "Custom Key: Not Installed"
Communication	
Serial Number	Serial number that uniquely identifies the communication module.
Firmware Version	Version of the communication module firmware.

VIEW Tab

1. These properties are view-only when the HHD is connected to the lock. Connect the HHD to the PIM400 to make changes.

AD-400/AD-401/AD-402 (Networked Locks)

Property	Description	Default
Heartbeat	The heartbeat is a brief communication from the lock to the PIM400. It allows an idle lock to check for messages. Range: 15 seconds - many hours. The value indicates the time between the heartbeats. Set to a shorter time (lower number) for more frequent communication. Set to a longer time (higher number) for less frequent communication. A smaller value will decrease battery life. A larger value will increase battery life.	10 minutes
Comm Loss Fail Mode	Lock state set when RF communication with the linked PIM400 fails. States: As-Is, Secure/Lock, Unsecure/Unlock	As-Is
Allow Extended Unlocks (Locks linked to PIM400-TD2 only)	Extended unlock permits the lock to stay in an indefinite unlock state. Enabling the Extended Unlock feature is required to implement a scheduled unlock period from an ACP.	Enabled
Report RTX for Host to unlock ¹	Determines how an AD-400 will handle a request to exit. If disabled, the AD-400 will only report that a request to exit has occurred. Disable if the access point does not need to be electronically unlocked to provide egress (if equipped with a crash bar) but the access control panel needs to be notified so that a forced door does not occur. If enabled, the AD-400 will report that a request to exit has occurred, and also will query the PIM400 to determine if the AD-400 should be electronically unlocked. Use this mode if the AD-400 needs to be electronically unlocked in order to provide egress.	Disabled
Relatch After: Timer/Door Status	Re-latch on: <ul style="list-style-type: none"> Timer Only (Lock when Timer expires (default 3 seconds) regardless of Door status or Position) On Door Open or Timer (Lock when the Door opens or Timer expires) On Door Close or Timer (Lock when the Door closes or Timer expires) 	Timer only
High Low Output (Locks linked to PIM400-TD2 only)	Polarity of the Request-to-Exit (RTX) signal.	Low: RTX
	Polarity of the Request-to-Enter (RTE) signal.	Low: RTE
	Polarity of the On Door Open, (Door Position Switch (DPS)) signal.	High: open
	Polarity of Trouble signal.	Low: trouble
First, Delay, Retry	First: First query a Lock makes to a PIM400 occurs immediately following presentation of a credential. First is the amount of time, in milliseconds, an AD-400 should wait before making its second query to a PIM400. This setting should be slightly greater than the fastest response time from the access control panel or host. This optimizes battery life and system performance. Delay: The idle time between subsequent queries. Shorter delays may reduce latency. Longer delays may enhance battery life. Retry: The maximum number of times an access point queries a PIM400 before the Lock goes back to sleep. The number of retries should be slightly greater than the longest response time from the access control panel or host. Retrys = [Max Response Time of Panel- First}/Delay] + 1	First: 300 msec. Delay: 200 msec. Retry: 5
Degraded (Cache) Mode: Card Bit Format*	Enter the number of bits on the cards being used to enable degraded mode. abilities. 0 = cache mode disabled	0
Degraded (Cache) Mode: Full Card Number or Facility Code*	Use the full card number or the facility codes of previously approved credentials in the Degraded (Cache) mode. Granting access is determined by "Full Card" content or just "Facility Code".	Full Card
Degraded (Cache) Mode: Purge unused after 5 days*	When enabled, deletes the cache entry after 5 days of non-use. If enabled, cards that have not accessed the lock within 5 days will be removed.	Disabled

EDIT Tab

* AD-402 does not support Cache mode; these options will be grayed out.

1. These properties are view-only when the HHD is connected to the lock. Connect the HHD to the PIM400 to make changes.

AD-400/AD-401/AD-402 (Networked Locks)

Edit Tab (Cont.)	Degraded (Cache) Mode: Clear Cache*	Deletes all valid user credentials from the Degraded (cache) memory. Allows you to manually clear cache memory.	n/a
	Card + PIN LED Mode	Disabled Mode 1: 5 left green and right red alternating blinks Mode 2: 5 left green and right red alternating blinks, plus two beeps	1
	Request to Enter	Report Request to Enter signal state to PIM400/401.	Always Enabled
	Wakeup status ¹	Displays the time, in seconds, the lock listens for Wake on Radio broadcasts from its linked PIM400/401.	Disabled
	Disable Interior Button LED	If checked, interior button LED blinking is disabled.	Disabled (unchecked)
	Max Entries Stored*	Number of credential cards or facility codes maintained in the cache. Minimum of 5, Maximum of 1000.	125
	ACP Timeout	Time (in seconds) to wait before determining communication from the ACP has failed.	10 seconds
	Battery Fail Mode	Lock state set when battery fails. As-Is, Secure/Lock, Unsecure/Unlock	As-Is
	FIPS201-2 Authentication	This checkbox will allow the user to choose whether to perform the full FIPS201-2 authentication for PIV credentials. Also, since this operation is not applicable on all lock types, it appears Grayed out (un-editable) for the following lock types: AD-400, AD-401.	unchecked
	* AD-402 does not support Cache mode; these options will be grayed out.		

1. These properties are view-only when the HHD is connected to the lock. Connect the HHD to the PIM400 to make changes.

AD-400/AD-401/AD-402 (Networked Locks)

Property	Description	Default				
Prox in Use	Proximity credential card types allowed. Selections: <ul style="list-style-type: none"> • HID/Kantech • ioProx* • GE/CASI • GE4001 • GE4002* • AWID* 	* Default formats				
Mag Track in Use	Magnetic card track that access data is to be read from. Track 1, 2 or 3	Track 2				
Enable Low Power Wake-Up	Active when Mag Track 1 or 3 is selected in "Mag Track in Use". By enabling Low Power Wake-Up and recording data on track 2, this option will allow longer battery life.	Enabled				
Smart Cards in Use	Smart card(s) to be used with the card reader. <ul style="list-style-type: none"> • 14443 UID(CSN) (when selected, disables all other 14443 selections and PIV format) • 14443 Secure MiFare Classic* • 14443 Secure MiFare Plus* • 14443 EV1 (NOC)* • 15693 UID (CSN)* <p>MTK1</p> <ul style="list-style-type: none"> • iClass credential formats for Reader Types which support Smart Cards <ul style="list-style-type: none"> • iClass 40-bit UID (CSN) • iClass 64-bit UID (CSN)* • HID iClass Classic* (only appears with Mi/MiK reader attached) • PIV credential formats for AD200 reader types which support Smart Cards. Range is 1 to 15. <table style="width: 100%; border: none;"> <tr> <td style="width: 50%; vertical-align: top;"> <ol style="list-style-type: none"> 1. 75 Bit PIV* 2. 58 Bit TWIC/CAC 3. 200 Bit FASC-N 4. 64 Bit (BCD) TWIC/CAC 5. 83 Bit TWIC/CAC 6. 66 Bit (58 Bit Format + TSM) TWIC/CAC 7. 64 Bit (58 Bit Format (no parity) + TSM) TWIC/CAC </td> <td style="width: 50%; vertical-align: top;"> <ol style="list-style-type: none"> 8. 91 Bit (83 Bit Format + TSM) TWIC/CAC 9. 40 Bit BCD 10. 40 Bit Reversed BCD 11. 64 Bit BCD 12. 64 Bit Reversed BCD 13. 128 Bit BCD 14. 128 Bit Reversed BCD 15. 58 Bit HSE </td> </tr> </table> <p>MTK2</p> <ul style="list-style-type: none"> • iClass/Felica credential formats for Reader Types which support Smart Cards <ul style="list-style-type: none"> • iClass/Felica 40-bit UID (CSN) • iClass/Felica 64-bit UID (CSN)* • HID iClass/iClass SE/iClass SEOS (only appears with Si2/SiK2 reader attached). Enabled by default. • PIV credential formats for AD200 reader types which support Smart Cards. Range is 1 to 15. <table style="width: 100%; border: none;"> <tr> <td style="width: 50%; vertical-align: top;"> <ol style="list-style-type: none"> 1. 75 Bit PIV* 2. 58 Bit TWIC/CAC 3. 200 Bit FASC-N 4. 64 Bit (BCD) TWIC/CAC 5. 83 Bit TWIC/CAC 6. 66 Bit (58 Bit Format + TSM) TWIC/CAC 7. 64 Bit (58 Bit Format (no parity) + TSM) TWIC/CAC </td> <td style="width: 50%; vertical-align: top;"> <ol style="list-style-type: none"> 8. 91 Bit (83 Bit Format + TSM) TWIC/CAC 9. 40 Bit BCD 10. 40 Bit Reversed BCD 11. 64 Bit BCD 12. 64 Bit Reversed BCD 13. 128 Bit BCD 14. 128 Bit Reversed BCD 15. 58 Bit HSE </td> </tr> </table> 	<ol style="list-style-type: none"> 1. 75 Bit PIV* 2. 58 Bit TWIC/CAC 3. 200 Bit FASC-N 4. 64 Bit (BCD) TWIC/CAC 5. 83 Bit TWIC/CAC 6. 66 Bit (58 Bit Format + TSM) TWIC/CAC 7. 64 Bit (58 Bit Format (no parity) + TSM) TWIC/CAC 	<ol style="list-style-type: none"> 8. 91 Bit (83 Bit Format + TSM) TWIC/CAC 9. 40 Bit BCD 10. 40 Bit Reversed BCD 11. 64 Bit BCD 12. 64 Bit Reversed BCD 13. 128 Bit BCD 14. 128 Bit Reversed BCD 15. 58 Bit HSE 	<ol style="list-style-type: none"> 1. 75 Bit PIV* 2. 58 Bit TWIC/CAC 3. 200 Bit FASC-N 4. 64 Bit (BCD) TWIC/CAC 5. 83 Bit TWIC/CAC 6. 66 Bit (58 Bit Format + TSM) TWIC/CAC 7. 64 Bit (58 Bit Format (no parity) + TSM) TWIC/CAC 	<ol style="list-style-type: none"> 8. 91 Bit (83 Bit Format + TSM) TWIC/CAC 9. 40 Bit BCD 10. 40 Bit Reversed BCD 11. 64 Bit BCD 12. 64 Bit Reversed BCD 13. 128 Bit BCD 14. 128 Bit Reversed BCD 15. 58 Bit HSE 	* Default formats
<ol style="list-style-type: none"> 1. 75 Bit PIV* 2. 58 Bit TWIC/CAC 3. 200 Bit FASC-N 4. 64 Bit (BCD) TWIC/CAC 5. 83 Bit TWIC/CAC 6. 66 Bit (58 Bit Format + TSM) TWIC/CAC 7. 64 Bit (58 Bit Format (no parity) + TSM) TWIC/CAC 	<ol style="list-style-type: none"> 8. 91 Bit (83 Bit Format + TSM) TWIC/CAC 9. 40 Bit BCD 10. 40 Bit Reversed BCD 11. 64 Bit BCD 12. 64 Bit Reversed BCD 13. 128 Bit BCD 14. 128 Bit Reversed BCD 15. 58 Bit HSE 					
<ol style="list-style-type: none"> 1. 75 Bit PIV* 2. 58 Bit TWIC/CAC 3. 200 Bit FASC-N 4. 64 Bit (BCD) TWIC/CAC 5. 83 Bit TWIC/CAC 6. 66 Bit (58 Bit Format + TSM) TWIC/CAC 7. 64 Bit (58 Bit Format (no parity) + TSM) TWIC/CAC 	<ol style="list-style-type: none"> 8. 91 Bit (83 Bit Format + TSM) TWIC/CAC 9. 40 Bit BCD 10. 40 Bit Reversed BCD 11. 64 Bit BCD 12. 64 Bit Reversed BCD 13. 128 Bit BCD 14. 128 Bit Reversed BCD 15. 58 Bit HSE 					

READER Tab

1. These properties are view-only when the HHD is connected to the lock. Connect the HHD to the PIM400 to make changes.

AD-400/AD-401/AD-402 (Networked Locks)

READER Tab	Beeper	Indicates if the Beeper is On or Off.	ON
	Keypad: Output Type	Wiegand or Magnetic output type.	Wiegand
	Keypad: Facility Code	A facility or site code is encoded into each card to increase security. A number from 0 to 255 on a 26-bit format card.	
	Keypad: Keys Buffered	Fixed number of key presses to buffer. Range is 1 to 11. Active only in keypad output modes that support buffered key presses. See Output formats 4, 6, 9 and 10 below.	4
	Keypad: Output Format	Sets the keypad data length and format mode. Range is 0 to 12. 0. Disable Keypad output 1. Mode 1: 4 Data Bits per Key without Parity (high nibble) 2. Mode 2: 4 Data Bits per Key with Parity 3. Mode 3: 8 Data Bits per Key without Parity 4. Mode 4: 8 Data Bits per Key with Parity 5. Mode 5: 4 Data Bits per Key, Buffered Key Presses without Parity 6. Mode 6: 4 Data Bits per Key, Buffered Key Presses with Parity 7. Mode 7: 26 Bit Wiegand Emulation 8. Mode 8: 4 Data Bits per Key without Parity (low nibble) 9. Mode 9: IR, 4 Data Bits per Key, Buffered Key Presses without Parity 10. Mode 10: IR, 4 Data Bits per Key, Buffered Key Presses with Parity 11. Mode 11: 8 Data Bits per Key, ASCII with parity 12. Mode 12: 32 Bit Wiegand Emulation	1

1. These properties are view-only when the HHD is connected to the lock. Connect the HHD to the PIM400 to make changes.

Controller Properties

- WPR400: pg 43
- PIM400 -TD2, -485, -VBB (PIM PROPERTIES): pg 46
- PIM400 -TD2, -485, -VBB (LOCK PROPERTIES): pg 47
- PIB300: pg 51
- WRI400: pg. [\(page 53\)](#)
- CT5000: pg. [\(page 55\)](#)

WPR400

	Property	Description
	General Properties	
	Model	Model of the device connected to the HHD.
	Power Status	Current voltage level and number of AA batteries.
	MAIN LOCK	
	RS485 Partner ID	Identifies the participating OEM software partner.
	Serial Number	Serial number that uniquely identifies the lock.
	Manufacture Date	Date the lock was manufactured
	Days Since Installed	Used for warranty purposes; it marks the beginning of the lock's functional life.
	Firmware Version	Current version of the firmware
	Bootloader Version	Version of the current bootloader. Allows new firmware to be loaded.
	Hardware Version	Current version of the printed circuit board.
	Credential Reader	
	Serial Number	Serial number that uniquely identifies the reader.
	Manufacture Date	Date the reader was manufactured.
	Firmware Version	Current version of the firmware
	Bootloader Version	Version of the current bootloader. Allows new firmware to be loaded.
	Hardware Version	Current version of the printed circuit board.
VIEW Tab	Reader Type	Type of Reader installed: <ul style="list-style-type: none"> • MagInsert • MagInsert + Keypad • MagSwipe • MagSwipe + Keypad • Keypad • Proximity • Proximity + Keypad • Smart Card • Smart Card + Keypad • Multi-Tech • Multi-Tech + Keypad • FIPS + Multi-Tech + Keypad • iClass + Multi-Tech • iClass + Multi-Tech + Keypad • Multi-Tech 2 • Multi-Tech 2 + Keypad • FIPS + Multi-Tech 2 + Keypad • Keypad 2 • iClass + Smart Only 2 • iClass + Smart Only 2 + Keypad
	Custom Key	If the reader supports reporting the status of custom configuration then SUS displays "Custom Key: Installed" or "Custom Key: Not Installed"
	Communication	
	Serial Number	Serial number that uniquely identifies the communication module.
	Firmware Version	Version of the communication module firmware.

WPR400

	Property	Description	Default
	Relatch After: Timer Length	Amount of time before the lock re-locks after being unlocked by a user presenting a valid credential.	3 seconds
	First, Delay, Retry	<p>First: First query a Lock makes to a PIM400 occurs immediately following presentation of a credential. First is the amount of time, in milliseconds, the WPR400 should wait before making its second query to a PIM400. This setting should be slightly greater than the fastest response time from the access control panel or host. This optimizes battery life and system performance.</p> <p>Delay: The idle time between subsequent queries. Shorter delays may reduce latency. Longer delays may enhance battery life.</p> <p>Retry: The maximum number of times the WPR400 queries a PIM400 before the Lock goes back to sleep. The number of retries should be slightly greater than the longest response time from the access control panel or host. Retrys = [{Max Response Time of Panel- First} / Delay] +1</p>	First: 300 msec. Delay: 200 msec. Retry: 5
EDIT Tab	Degraded (Cache) Mode: Full Card Number or Facility Code	Use the full card number or the facility codes of previously approved credentials in the Degraded (Cache) mode. Granting access is determined by "Full Card" content or just "Facility Code".	Full Card
	Degraded (Cache) Mode: Purge unused after 5 days	When enabled, deletes the cache entry after 5 days of non-use. If enabled, cards that have not accessed the lock within 5 days will be removed.	Disabled
	Degraded (Cache) Mode: Clear Cache	Deletes all valid user credentials from the Degraded (cache) memory. Allows you to manually clear cache memory.	n/a
	Card + PIN LED mode	Disabled Mode 1: 2 alternating blinks Mode 2: Solid Green / 2 red right blinks	1
	Wakeup Status	Displays the time, in seconds, the lock listens for Wake on Radio broadcasts from its linked PIM400.	Disabled
	Max Entries Stored	Number of credential cards or facility codes maintained in the cache. Minimum of 5, Maximum of 1000.	125
	ACP Timeout	Time (in seconds) to wait before determining communication from the ACP has failed.	10 seconds

WPR400

	Property	Description	Default																																			
READER Tab	Prox in Use	Proximity credential card types allowed. Selections: <ul style="list-style-type: none"> • HID/Kantech ioProx* • GE/CASI • GE4001 • GE4002* • AWID* 	* Default formats																																			
	Mag Track in Use	Magnetic card track that access data is to be read from. Select Track 1, 2 or 3	Track 2																																			
	Enable Low Power Wake-Up	Active when Mag Track 1 or 3 is selected in "Mag Track in Use". By enabling Low Power Wake-Up and recording data on track 2, this option will allow longer battery life.	Enabled																																			
	Smart Cards in Use	Smart card(s) to be used with the card reader. <ul style="list-style-type: none"> • 14443 UID(CSN) (when selected, disables all other 14443 selections and PIV format) • 14443 Secure MiFare Classic* • 14443 Secure MiFare Plus* • 14443 EV1 (NOC)* • 15693 UID (CSN)* 	* Default formats																																			
		<p>MTK1</p> <ul style="list-style-type: none"> • iClass credential formats for Reader Types which support Smart Cards <ul style="list-style-type: none"> • iClass 40-bit UID (CSN) • iClass 64-bit UID (CSN)* • HID iClass Classic* (only appears with Mi/MiK reader attached) • PIV credential formats for AD200 reader types which support Smart Cards. Range is 1 to 15. <table style="width: 100%; border: none;"> <tr> <td style="width: 50%;">1. 75 Bit PIV*</td> <td style="width: 50%;">8. 91 Bit (83 Bit Format + TSM)</td> </tr> <tr> <td>2. 58 Bit TWIC/CAC</td> <td> TWIC/CAC</td> </tr> <tr> <td>3. 200 Bit FASC-N</td> <td>9. 40 Bit BCD</td> </tr> <tr> <td>4. 64 Bit (BCD) TWIC/CAC</td> <td>10. 40 Bit Reversed BCD</td> </tr> <tr> <td>5. 83 Bit TWIC/CAC</td> <td>11. 64 Bit BCD</td> </tr> <tr> <td>6. 66 Bit (58 Bit Format + TSM) TWIC/CAC</td> <td>12. 64 Bit Reversed BCD</td> </tr> <tr> <td>7. 64 Bit (58 Bit Format (no parity) + TSM) TWIC/CAC</td> <td>13. 128 Bit BCD</td> </tr> <tr> <td></td> <td>14. 128 Bit Reversed BCD</td> </tr> <tr> <td></td> <td>15. 58 Bit HSE</td> </tr> </table> <p>MTK2</p> <ul style="list-style-type: none"> • iClass/Felica credential formats for Reader Types which support Smart Cards <ul style="list-style-type: none"> • iClass/Felica 40-bit UID (CSN) • iClass/Felica 64-bit UID (CSN)* • HID iClass/iClass SE/iClass SEOS (only appears with Si2/SiK2 reader attached). Enabled by default. • PIV credential formats for AD200 reader types which support Smart Cards. Range is 1 to 15. <table style="width: 100%; border: none;"> <tr> <td style="width: 50%;">1. 75 Bit PIV*</td> <td style="width: 50%;">8. 91 Bit (83 Bit Format + TSM)</td> </tr> <tr> <td>2. 58 Bit TWIC/CAC</td> <td> TWIC/CAC</td> </tr> <tr> <td>3. 200 Bit FASC-N</td> <td>9. 40 Bit BCD</td> </tr> <tr> <td>4. 64 Bit (BCD) TWIC/CAC</td> <td>10. 40 Bit Reversed BCD</td> </tr> <tr> <td>5. 83 Bit TWIC/CAC</td> <td>11. 64 Bit BCD</td> </tr> <tr> <td>6. 66 Bit (58 Bit Format + TSM) TWIC/CAC</td> <td>12. 64 Bit Reversed BCD</td> </tr> <tr> <td>7. 64 Bit (58 Bit Format (no parity) + TSM) TWIC/CAC</td> <td>13. 128 Bit BCD</td> </tr> <tr> <td></td> <td>14. 128 Bit Reversed BCD</td> </tr> <tr> <td></td> <td>15. 58 Bit HSE</td> </tr> </table> 	1. 75 Bit PIV*	8. 91 Bit (83 Bit Format + TSM)	2. 58 Bit TWIC/CAC	TWIC/CAC	3. 200 Bit FASC-N	9. 40 Bit BCD	4. 64 Bit (BCD) TWIC/CAC	10. 40 Bit Reversed BCD	5. 83 Bit TWIC/CAC	11. 64 Bit BCD	6. 66 Bit (58 Bit Format + TSM) TWIC/CAC	12. 64 Bit Reversed BCD	7. 64 Bit (58 Bit Format (no parity) + TSM) TWIC/CAC	13. 128 Bit BCD		14. 128 Bit Reversed BCD		15. 58 Bit HSE	1. 75 Bit PIV*	8. 91 Bit (83 Bit Format + TSM)	2. 58 Bit TWIC/CAC	TWIC/CAC	3. 200 Bit FASC-N	9. 40 Bit BCD	4. 64 Bit (BCD) TWIC/CAC	10. 40 Bit Reversed BCD	5. 83 Bit TWIC/CAC	11. 64 Bit BCD	6. 66 Bit (58 Bit Format + TSM) TWIC/CAC	12. 64 Bit Reversed BCD	7. 64 Bit (58 Bit Format (no parity) + TSM) TWIC/CAC	13. 128 Bit BCD		14. 128 Bit Reversed BCD		15. 58 Bit HSE
1. 75 Bit PIV*	8. 91 Bit (83 Bit Format + TSM)																																					
2. 58 Bit TWIC/CAC	TWIC/CAC																																					
3. 200 Bit FASC-N	9. 40 Bit BCD																																					
4. 64 Bit (BCD) TWIC/CAC	10. 40 Bit Reversed BCD																																					
5. 83 Bit TWIC/CAC	11. 64 Bit BCD																																					
6. 66 Bit (58 Bit Format + TSM) TWIC/CAC	12. 64 Bit Reversed BCD																																					
7. 64 Bit (58 Bit Format (no parity) + TSM) TWIC/CAC	13. 128 Bit BCD																																					
	14. 128 Bit Reversed BCD																																					
	15. 58 Bit HSE																																					
1. 75 Bit PIV*	8. 91 Bit (83 Bit Format + TSM)																																					
2. 58 Bit TWIC/CAC	TWIC/CAC																																					
3. 200 Bit FASC-N	9. 40 Bit BCD																																					
4. 64 Bit (BCD) TWIC/CAC	10. 40 Bit Reversed BCD																																					
5. 83 Bit TWIC/CAC	11. 64 Bit BCD																																					
6. 66 Bit (58 Bit Format + TSM) TWIC/CAC	12. 64 Bit Reversed BCD																																					
7. 64 Bit (58 Bit Format (no parity) + TSM) TWIC/CAC	13. 128 Bit BCD																																					
	14. 128 Bit Reversed BCD																																					
	15. 58 Bit HSE																																					

WPR400

READER Tab	Beeper	Indicates if the Beeper is On or Off.	ON
	Keypad: Output Type	Wiegand or Magnetic output type.	Wiegand
	Keypad: Facility Code	A facility or site code is encoded into each card to increase security. A number from 0 to 255 on a 26-bit format card.	1
	Keypad: Keys Buffered	Fixed number of key presses to buffer. Range in 1 to 11. Active only in keypad output modes that support buffered key presses. See Output formats 4, 6, 9 and 10 below.	4
	Keypad: Output Format	Sets the keypad data length and format mode. Range is 0 to 12. 0. Disable Keypad output 1. Mode 1: 4 Data Bits per Key without Parity (high nibble) 2. Mode 2: 4 Data Bits per Key with Parity 3. Mode 3: 8 Data Bits per Key without Parity 4. Mode 4: 8 Data Bits per Key with Parity 5. Mode 5: 4 Data Bits per Key, Buffered Key Presses without Parity 6. Mode 6: 4 Data Bits per Key, Buffered Key Presses with Parity 7. Mode 7: 26 Bit Wiegand Emulation 8. Mode 8: 4 Data Bits per Key without Parity (low nibble) 9. Mode 9: IR, 4 Data Bits per Key, Buffered Key Presses without Parity 10. Mode 10: IR, 4 Data Bits per Key, Buffered Key Presses with Parity 11. Mode 11: 8 Data Bits per Key, ASCII with parity 12. Mode 12: 32 Bit Wiegand Emulation	1

PIM400 -TD2, -485, -VBB (PIM PROPERTIES)

	Property	Description
VIEW Tab	General Properties	
	Model	Model number of the device connected to the HDD.
	Source ID	Unique identifier for the PIM400.
	FIPS 201-2 Capable (PIM-485 & PIM-VBB ONLY)	The Yes or No value for this field indicates whether the device (i.e. Lock/Reader/PIM combination) is FIPS201-2 Capable or not.
	PIM	
	RS485 Partner ID	Identifies the participating OEM software partner.
	Firmware Version	Version of the current firmware file. Automatically updated when a new firmware version is loaded.
	Bootloader version	Version of the current bootloader. Allows new firmware to be loaded.
	Serial No.	Serial number that uniquely identifies the device.
	Manufacture Date	Date the device was manufactured.
	Days since Installed	Used for warranty purposes; marks the beginning of the lock's functional life.
	Hardware Version	
	Communication	
Firmware Version	Version of the communication module firmware.	

PIM400 -TD2, -485, -VBB (PIM PROPERTIES)

	Property	Description	Default
EDIT Tab	Unique ID	Set the Unique Identification number of the PIM400. Range: 0 to 65534.	
	Freq Channel	Radio Frequency Channel used for communication with wireless devices. One of ten RF channels can be set.	1
	RS-485 Address	PIM400 -485 and PIM400-VBB ONLY. Set the RS-485 network address of the PIM400/401. Address range 0-254	0
	Low Door	PIM400 -485, -VBB ONLY. Set the Low address for the range of door addresses available for linking. Range: 0 to 255	0
	High Door	PIM400 -485, -VBB ONLY. Set the High address for the range of door addresses available for linking. Range: 0 to 255	15
	Channel Switching	Dynamic Channel Switching is used to improve immunity to RF channel interference. One of three RF channel groups can be set.	Disabled
	Wakeup	When enabled, this feature causes wireless devices linked to the PIM400/401 to respond within seconds to a centralized command from the access control panel. When disabled, the wireless devices will respond only during their heartbeat, which could result in a delay. Range 0 to 10 seconds. 0 = disabled	Disabled
	Output Type (PIM400-TD2 only)	Magnetic, Wiegand or Automatic. Outputs the Credential Card and Keypad data in either Magnetic or Wiegand format. When Automatic is selected, the PIM400-TD2 will detect the Credential Card and Keypad data format and then send the received data in its original data format.	Automatic
LINK Tab (PIM400/401, -485, -VBB only)	Property	Description	Default
	Select Door	Select the door address desired to be linked to the PIM400 -485.	

PIM400 -TD2, -485, -VBB (LOCK PROPERTIES)

	Property	Description
VIEW Tab	General Properties	
	Model	Model of the device connected to the HHD.
	Door Number	Allows the selection of a door connected to the PIM400 to display its properties.
	Power Status	Current voltage level of the AA batteries.
	FIPS 201-2 capable	Applicable if AD401/AD402 is linked at this door address.
	PIM	
	Firmware Version	Version of the firmware.
	Communication	
	Firmware Version	Version of the communication module firmware.

PIM400 -TD2, -485, -VBB (LOCK PROPERTIES)

	Property	Description	Default
EDIT Tab	Heartbeat	<p>The heartbeat is a brief communication from the lock to the PIM400. The heartbeat allows an idle lock to check for messages from the PIM400. By default, this occurs every 10 minutes, but can be adjusted in the range of 15 seconds to many hours.</p> <p>The value indicates the time between the heartbeats. Set the value to a shorter time (lower number) to achieve more frequent communication while the lock is idle. Set the value to a longer time (higher number) to achieve less frequent communication. A smaller value will decrease battery life. A larger value will increase battery life.</p>	10 minutes
	Comm Loss Fail Mode	<p>Lock state set when RF communication with the linked PIM400 fails.</p> <p>Selections: As-Is, Secure/Lock, Unsecure/Unlock</p>	As-Is
	Allow Extended Unlocks (PIM400-TD2 only)	<p>Extended unlock is a feature that permits the lock to stay in an indefinite unlock state.</p> <p>Enabling the Extended Unlock feature is required to implement a scheduled unlock period from an ACP.</p>	enabled
	Report RTX for Host to Unlock	<p>This feature determines how a Wireless Access Point (Door) will handle a request to exit.</p> <p>If not checked (disabled), then the access point will only report that a request to exit has occurred. Use this mode if the access point does not need to be electronically unlocked in order to provide egress (for instance, the access point has a crash bar) but the access control panel needs to be notified so that a forced door does not occur.</p> <p>If checked (enabled), then the access point will not only report that a request to exit has occurred, but will query the PIM400 (as in a card swipe) to determine if the access point should be electronically unlocked. Use this mode if the access point needs to be electronically unlocked in order to provide egress.</p>	Enabled
	Relatch After: Timer Length	Amount of time, in seconds, before the lock re-locks after being unlocked by a user presenting a valid credential.	3 seconds
	Relatch After : Timer/Door Status	<p>Re-latch on:</p> <ul style="list-style-type: none"> • Timer Only: Lock when timer expires regardless of Door status or Position • On Door Open or Timer: Lock when the Door opens or Timer expires • On Door Close or Timer: Lock when the Door closes or Timer expires 	Timer only
	High Low Output (PIM400-TD2 only)	Polarity of the Request-to-Exit (RTX) signal.	Low: RTX
		Polarity of the Request-to-Enter (RTE) signal.	Low: RTE
		Polarity of the On Door Open, (Door Position Switch (DPS)) signal.	High: open
		Polarity of Trouble signal.	Low: trouble
	First, Delay, Retry	<p>First: First query a lock makes to a PIM400 occurs immediately following presentation of a credential. First is the amount of time, in milliseconds, an access point should wait before making its second query to a PIM400. This setting should be slightly greater than the fastest response time from the access control panel or host. This optimizes battery life and system performance.</p> <p>Delay: The idle time between subsequent queries. Shorter delays may reduce latency. Longer delays may enhance battery life.</p> <p>Retry: The maximum number of times and access point queries a PIM400 before the lock goes back to sleep. The number of retries should be slightly greater than the longest response time from the access control panel or host. $Retry = \lceil \frac{\text{Max Response Time of Panel} - \text{First}}{\text{Delay}} \rceil + 1$.</p>	<p>First: 300</p> <p>Delay: 200</p> <p>Retry: 5</p>
Degraded (Cache) Mode: Card Bit Format	Enter the number of bits on the cards being used to enable degraded mode.abilities. 0 = cache mode disabled	0	

PIM400 -TD2, -485, -VBB (LOCK PROPERTIES)

EDIT Tab (Cont.)	Degraded (Cache) Mode: Purge unused after 5 days*	When enabled, deletes the cache entry after 5 days of non-use. If enabled, cards that have not accessed the lock within 5 days will be removed.	Disabled
	Degraded (Cache) Mode: PIM485 Card Removal*	PIM400 -485, -VBB ONLY. Only displayed when a Legacy PIM is connected. If disabled only time or a full cache will remove an entry from the cache. If enabled only a full cache or receiving a RS-485 Deny Access command will remove an entry from the cache.	Disabled
	Degraded (Cache) Mode: Full Card Number or Facility Code*	Use the full card number or the facility codes of previously approved credentials in the Degraded (Cache) mode. Granting access is determined by "Full Card" content or just "Facility Code".	Full Card
	Degraded (Cache) Mode: Clear Cache*	Deletes all valid user credentials from the Degraded (cache) memory. Allows you to manually clear cache memory.	n/a
	Card + PIN LED mode	Disabled Mode 1: 5 left green and right red alternating blinks Mode 2: 5 left green and right red alternating blinks, plus two beeps	1
	Request to Enter	Report Request to Enter signal state to PIM400	Disabled
	Wakeup	Displays the time, in seconds, the Wireless Access Point Device listens for Wake on Radio broadcasts from its linked PIM400.	Disabled
	Max Entries Stored*	Number of credential cards or facility codes maintained in the cache. Minimum of 5, Maximum of 1000.	125
	ACP timeout	Time (in seconds) to wait before determining communication from the ACP has failed.	10 seconds
	Power Fail Mode	Lock state set when battery fails. As-Is, Secure/Lock, Unsecure/Unlock	As-Is
	Pin Required	TD2 Only	Disabled (unchecked)
	Disable Interior Button LED	TD2 and 485	Enabled (unchecked)
	FIPS 201-2 Authentication	Checkbox will be displayed only if AD402 is connected.	unchecked
* Not applicable for AD-302 & AD-402			

PIM400 -TD2, -485, -VBB (LOCK PROPERTIES)

Property	Description	Default																																
Prox in Use	Proximity credential card types allowed. Selections: <ul style="list-style-type: none"> • HID/Kantech • ioProx* • GE/CASI • GE4001 • GE4002* • AWID* 	* Default formats																																
Mag Track in Use	Magnetic card track that access data is to be read from. Select Track 1, 2 or 3	Track 2																																
Enable Low Power Wake-Up	Active when Mag Track 1 or 3 is selected in "Mag Track in Use". By enabling Low Power Wake-Up and recording data on track 2, this option will allow longer battery life.	Enabled																																
Smart Cards in Use	Smart card(s) to be used with the card reader. <ul style="list-style-type: none"> • 14443 UID(CSN) (when selected, disables all other 14443 selections and PIV format) • 14443 Secure MiFare Classic* • 14443 Secure MiFare Plus* • 14443 EV1 (NOC)* • 15693 UID (CSN)* <p>MTK1</p> <ul style="list-style-type: none"> • iClass credential formats for Reader Types which support Smart Cards <ul style="list-style-type: none"> • iClass 40-bit UID (CSN) • iClass 64-bit UID (CSN)* • HID iClass Classic* (only appears with Mi/MiK reader attached) • PIV credential formats for AD200 reader types which support Smart Cards. Range is 1 to 15. <table style="width: 100%; border: none;"> <tr> <td style="width: 50%;">1. 75 Bit PIV*</td> <td style="width: 50%;">8. 91 Bit (83 Bit Format + TSM)</td> </tr> <tr> <td>2. 58 Bit TWIC/CAC</td> <td>9. 40 Bit BCD</td> </tr> <tr> <td>3. 200 Bit FASC-N</td> <td>10. 40 Bit Reversed BCD</td> </tr> <tr> <td>4. 64 Bit (BCD) TWIC/CAC</td> <td>11. 64 Bit BCD</td> </tr> <tr> <td>5. 83 Bit TWIC/CAC</td> <td>12. 64 Bit Reversed BCD</td> </tr> <tr> <td>6. 66 Bit (58 Bit Format + TSM) TWIC/CAC</td> <td>13. 128 Bit BCD</td> </tr> <tr> <td>7. 64 Bit (58 Bit Format (no parity) + TSM) TWIC/CAC</td> <td>14. 128 Bit Reversed BCD</td> </tr> <tr> <td></td> <td>15. 58 Bit HSE</td> </tr> </table> <p>MTK2</p> <ul style="list-style-type: none"> • iClass/Felica credential formats for Reader Types which support Smart Cards <ul style="list-style-type: none"> • iClass/Felica 40-bit UID (CSN) • iClass/Felica 64-bit UID (CSN)* • HID iClass/iClass SE/iClass SEOS (only appears with Si2/SiK2 reader attached). Enabled by default. • PIV credential formats for AD200 reader types which support Smart Cards. Range is 1 to 15. <table style="width: 100%; border: none;"> <tr> <td style="width: 50%;">1. 75 Bit PIV*</td> <td style="width: 50%;">8. 91 Bit (83 Bit Format + TSM)</td> </tr> <tr> <td>2. 58 Bit TWIC/CAC</td> <td>9. 40 Bit BCD</td> </tr> <tr> <td>3. 200 Bit FASC-N</td> <td>10. 40 Bit Reversed BCD</td> </tr> <tr> <td>4. 64 Bit (BCD) TWIC/CAC</td> <td>11. 64 Bit BCD</td> </tr> <tr> <td>5. 83 Bit TWIC/CAC</td> <td>12. 64 Bit Reversed BCD</td> </tr> <tr> <td>6. 66 Bit (58 Bit Format + TSM) TWIC/CAC</td> <td>13. 128 Bit BCD</td> </tr> <tr> <td>7. 64 Bit (58 Bit Format (no parity) + TSM) TWIC/CAC</td> <td>14. 128 Bit Reversed BCD</td> </tr> <tr> <td></td> <td>15. 58 Bit HSE</td> </tr> </table> 	1. 75 Bit PIV*	8. 91 Bit (83 Bit Format + TSM)	2. 58 Bit TWIC/CAC	9. 40 Bit BCD	3. 200 Bit FASC-N	10. 40 Bit Reversed BCD	4. 64 Bit (BCD) TWIC/CAC	11. 64 Bit BCD	5. 83 Bit TWIC/CAC	12. 64 Bit Reversed BCD	6. 66 Bit (58 Bit Format + TSM) TWIC/CAC	13. 128 Bit BCD	7. 64 Bit (58 Bit Format (no parity) + TSM) TWIC/CAC	14. 128 Bit Reversed BCD		15. 58 Bit HSE	1. 75 Bit PIV*	8. 91 Bit (83 Bit Format + TSM)	2. 58 Bit TWIC/CAC	9. 40 Bit BCD	3. 200 Bit FASC-N	10. 40 Bit Reversed BCD	4. 64 Bit (BCD) TWIC/CAC	11. 64 Bit BCD	5. 83 Bit TWIC/CAC	12. 64 Bit Reversed BCD	6. 66 Bit (58 Bit Format + TSM) TWIC/CAC	13. 128 Bit BCD	7. 64 Bit (58 Bit Format (no parity) + TSM) TWIC/CAC	14. 128 Bit Reversed BCD		15. 58 Bit HSE	* Default formats
1. 75 Bit PIV*	8. 91 Bit (83 Bit Format + TSM)																																	
2. 58 Bit TWIC/CAC	9. 40 Bit BCD																																	
3. 200 Bit FASC-N	10. 40 Bit Reversed BCD																																	
4. 64 Bit (BCD) TWIC/CAC	11. 64 Bit BCD																																	
5. 83 Bit TWIC/CAC	12. 64 Bit Reversed BCD																																	
6. 66 Bit (58 Bit Format + TSM) TWIC/CAC	13. 128 Bit BCD																																	
7. 64 Bit (58 Bit Format (no parity) + TSM) TWIC/CAC	14. 128 Bit Reversed BCD																																	
	15. 58 Bit HSE																																	
1. 75 Bit PIV*	8. 91 Bit (83 Bit Format + TSM)																																	
2. 58 Bit TWIC/CAC	9. 40 Bit BCD																																	
3. 200 Bit FASC-N	10. 40 Bit Reversed BCD																																	
4. 64 Bit (BCD) TWIC/CAC	11. 64 Bit BCD																																	
5. 83 Bit TWIC/CAC	12. 64 Bit Reversed BCD																																	
6. 66 Bit (58 Bit Format + TSM) TWIC/CAC	13. 128 Bit BCD																																	
7. 64 Bit (58 Bit Format (no parity) + TSM) TWIC/CAC	14. 128 Bit Reversed BCD																																	
	15. 58 Bit HSE																																	

READER Tab

PIM400 -TD2, -485, -VBB (LOCK PROPERTIES)

READER Tab	Beeper	Indicates if the Beeper is On or Off.	ON
	Keypad: Output Type	Wiegand or Magnetic output type.	Wiegand
	Keypad: Facility Code	A facility or site code is encoded into each card to increase security. A number from 0 to 255 on a 26-bit format card.	1
	Keypad: Keys Buffered	Fixed number of key presses to buffer. Range in 1 to 11. Active only in keypad output modes that support buffered key presses. See Output formats 4, 6, 9 and 10 below.	4
	Keypad: Output Format	Sets the keypad data length and format mode. Range is 0 to 12. 0. Disable Keypad output 1. Mode 1: 4 Data Bits per Key without Parity (high nibble) 2. Mode 2: 4 Data Bits per Key with Parity 3. Mode 3: 8 Data Bits per Key without Parity 4. Mode 4: 8 Data Bits per Key with Parity 5. Mode 5: 4 Data Bits per Key, Buffered Key Presses without Parity 6. Mode 6: 4 Data Bits per Key, Buffered Key Presses with Parity 7. Mode 7: 26 Bit Wiegand Emulation 8. Mode 8: 4 Data Bits per Key without Parity (low nibble) 9. Mode 9: IR, 4 Data Bits per Key, Buffered Key Presses without Parity 10. Mode 10: IR, 4 Data Bits per Key, Buffered Key Presses with Parity 11. Mode 11: 8 Data Bits per Key, ASCII with parity 12. Mode 12: 32 Bit Wiegand Emulation	1

PIB300

	Property	Description
VIEW Tab	General Properties	
	Model	Model of the device connected to the HHD.
	PIB	
	Firmware Version	Version of the firmware file. Automatically updated when a new firmware file is loaded.
	Bootloader Version	Version of the current bootloader. Allows new firmware to be loaded.
	Serial No.	Serial number that uniquely identifies the device.
	Manufacture Date	Date the device was manufactured.
	Days since Installed	Used for warranty purposes; marks the beginning of the lock's functional life.
Hardware Version	Current version of the printed circuit main board.	

PIB300

	Property	Description	Default
EDIT Tab	Standard/Legacy VIP	RS-485 network communication format: Standard (Schlage RSI RS-485 protocol) or Legacy VIP Protocol.	Standard
	Number of doors	Number of doors connected to the RS-485 network.	2
	Lock 1 Address	RS-485 address for Lock 1, Range: 0 to 254	0
	Lock 2 Address	RS-485 address for Lock 2, Range: 0 to 254	1
	Output Type	Magnetic, Wiegand or Automatic. Outputs the Credential Card and Keypad data in either Magnetic or Wiegand format. When Automatic is selected, the PIB300 will detect the Credential Card and Keypad data format and then send the received data in its original data format.	Automatic
	Host Control: LED Control	Off= two-line led control of lock led indication On=single-line led control of lock led indication	Unchecked
	Host Control: LED Standard	Off=led standard (active low signal from access control panel) On=led invert (active high signal from access control panel.)	Unchecked
	Host Control: LED Style	Off=led style std. (For use on two led system.) On=special case. If panel tries to light both leds (at the same time) neither of them lights. Beeper is not controlled by panel with this switch on. S1-1 must be set to off when this switch is set to on.	Unchecked
	Host Control: Lock Control from ACP	Off=normally open lock control from panel On=normally closed lock control from panel	Unchecked
	Host Control: Beep Std/Inverted	Off=beep standard (active low signal from access control panel) On=beep inverted (active high signal from access control panel)	Unchecked
	Output Reporting: Door Status	Off=normally open door status output (when door closed) On=normally closed door status output (when door closed)	Unchecked
	Output Reporting: Request to Exit (RTX)	Off=normally open RTX output when lever not depressed On=normally closed RTX output when lever not depressed	Unchecked
	Output Reporting: Spare	Off=normally open spare output (normal = key not used/latch extended, locked position) On=normally closed spare output (normal = key not used/latch extended, locked position)	Unchecked
Output Reporting: Spare Status	Off=spare output provides status of key use (rta) - if lock is equipped w/option On=spare output provides status of latch bolt monitor (lbm) - if lock is equipped w/option	Unchecked	
Output Reporting: Spare Provides	Off=spare output does not provide troubles status. Selection on 9 is used On=spare output provides troubles status. Selection on 9 is ignored	Unchecked	

WRI400

	Property	Description	
VIEW Tab	General Properties		
	Model	Model number of the device connected to the HHD.	
	Main Lock		
	RS485 Partner ID	Identifies the participating OEM software partner.	
	Serial Number	Serial number that uniquely identifies the WRI400.	
	Manufacture Date	Date the WRI400 was manufactured.	
	Days Since Installed	Used for warranty purposes; marks the beginning of the WRI400 functional life.	
	Firmware Version	Version of the current firmware file. Automatically updated when new firmware file is loaded.	
	Hardware Version	Current version of the printed circuit main board.	
	Bootloader Version	Version of the current bootloader. Allows new firmware to be loaded.	
	Communication		
	Serial Number	Serial number that uniquely identifies the communication module.	
	Firmware Version	Version of the communication module firmware.	
EDIT Tab	Property	Description	Default
	Heartbeat	The heartbeat is a brief communication from the WRI400 to the PIM400. It allows the WRI400 to check for messages. Range: 1 s. – 65535 s. The value indicates the time between the heartbeats. Set to a shorter time (lower number) for more frequent communication. Set to a longer time (higher number) for less frequent communication. A smaller value will decrease battery life. A larger value will increase battery life.	10 minutes
	Comm Loss Fail Mode	WRI400 state set when the RF communication with the linked PIM400 fails. States: As-Is, Secure/Lock, Unsecure/Unlock	As-Is
	Allow Extended Unlocks	Extended unlock permits the WRI400 to stay in an indefinite unlock state (available only in a PIM400-TD2). Enabling the Extended Unlock feature is required to implement a scheduled unlock period from an Access Control Panel.	Enabled
	Report RTX for Host to unlock	Determines how the WRI400 handles a request to exit. If disabled, the WRI400 will only report that a request to exit has occurred. Disable if the WRI400 does not need to be electronically unlocked to provide egress (if equipped with a crash bar) but the access control panel needs to be notified so that a forced door does not occur. If enabled, the WRI400 will report that a request to exit has occurred, and also will query the PIM400 to determine if it should be electronically unlocked. Use this mode if the WRI400 needs to be electronically unlocked in order to provide egress.	Enabled
	Relatch After	Amount of time before the WRI400 re-locks after being unlocked by a user presenting a valid credential. The value set in the HHD is only used if the Access Control Panel (ACP) responds with a "Momentary Unlock" command. When the Access Control Panel sends the number of seconds to unlock the WRI400 then the relatch after value set in the HHD is ignored.	3 seconds
Relatch After: Timer/Door Status	Timer Only: Locks the WRI400 when timer expires regardless of its status or position. On Door Open or Timer: Locks WRI400 when it opens or Timer expires. On Door Close or Timer: Locks WRI400 when it closes or Timer expires.	Timer Only	

WRI400

EDIT Tab (cont.)	Output (PIM400-TD2) On Door Open	Signaled through the PIM400-TD2 to the Access Control Panel, it sets the polarity of the Request to Enter (RTE) signal.	Active High
	Output (PIM400-TD2) On Request to Exit: Active High/Active Low	Signaled through the PIM400-TD2 to the Access Control Panel, it sets the polarity of the Request to Exit (RTX) signal.	Active Low
	Output (PIM400-TD2) On Trouble: Active High/Active Low	Signaled through the PIM400-TD2 to the Access Control Panel, this sets the polarity of the Trouble signal.	Active Low
	WRI400 - Input Request to Enter: Active Open/Active Close	This sets the polarity of the Request To Enter signal into the WRI400. Default is when the switch is closed and the WRI400 reads and reports a Request to Enter.	Active Close
	WRI400 - Input Request to Exit: Active Open/Active Close	This sets the polarity of the Request To Exit signal into the WRI400. Default is when the switch is closed and the WRI400 reads and reports a Request to Exit.	Active Close
	Reader 1 Tamper: Active Open/Active Closed	This sets the polarity of the Reader 1 Tamper signal into the WRI400. Default is when the switch is closed and the WRI400 reads and reports a Reader 1 Tamper.	Active Close
	Reader 2 Tamper: Active Open/Active Closed	This sets the polarity of the Reader 2 Tamper signal into the WRI400. Default is when the switch is closed and the WRI400 reads and reports a Reader 2 Tamper.	Active Close
	Door Position Switch (DPS): Active Open/Active Closed	This sets the polarity of the Door Position Switch (DPS) signal into the WRI400. Default is when the switch is closed and the WRI400 reads and reports the door closed.	Active close
	First, Delay, Retry	<p>First: First query the WRI400 makes to a PIM400 occurs immediately following presentation of a credential. This parameter is the amount of time, in milliseconds a WRI400 should wait before making its second query to a PIM400. This setting should be slightly greater than the fastest response time from the access control panel or host to any message originated by the WRI400. This optimizes battery life and system performance.</p> <p>Delay: The idle time between subsequent queries. Shorter delays may reduce latency, but also decrease battery life. Longer delays may enhance battery life.</p> <p>Retry: The maximum number of times the WRI400 queries a PIM400 before it goes back to sleep. The number of retries should be slightly greater than the longest response time from the access control panel or host.</p> <p>Retries = [{Max Response Time of Panel - First } / Delay] +1</p>	First: 300 msec. Delay: 200 msec. Retry: 5 times
	Degraded (Cache) Mode: Card Bit Format	Enter the number of bits on the cards being used to enable degraded mode.abilities. 0 = cache mode disabled	0
	Degraded (Cache) Mode: Full Card Number or Facility Code	Use the full card number or the facility codes of previously approved credentials in the Degraded (Cache) mode. Granting access is determined by "Full Card" content or just "Facility Code".	Full Card
	Degraded (Cache) Mode: Purge unused after 5 days	When enabled, deletes the cache entry after 5 days of non-use. If enabled, cards that have not accessed the lock within 5 days will be removed.	Disabled

WRI400

EDIT Tab (cont.)	Degraded (Cache) Mode: PIM485 Card Removal	PIM400 -485, -VBB ONLY Only displayed when a PIM400-485 is connected. If disabled, both ACP's refusing access (no access grant) and ACP's explicit deny access (Deny Access Command) will remove an entry. If enabled, only ACP's explicit deny access command will remove an entry from the cache.	Disabled
	Degraded (Cache) Mode: Clear Cache	Deletes all valid user credentials from the Degraded (cache) memory. Allows you to manually clear cache memory.	n/a
	Max Entries Stored	Number of credential cards or facility codes maintained in the cache. Minimum of 5, Maximum of 1000	125
	ACP Timeout	Time (in seconds) to wait before determining communication from the access control panel has failed.	10 seconds
	Wakeup Status	Displays the time, in seconds, the WRI400 listens for Wakeup on Radio broadcasts from its linked PIM400.	Disabled
	Strike Relay: Normally Open (Secure) Normally Closed (Secure)	When Normally-closed (Secure), the normally-closed side of the relay is the secure side. (Needs to read a valid credential before changing the relay polarity.)	Normally Closed (Secure)
	Aux Relay: Normally Open (Secure) Normally Closed (Secure)	When Normally-closed (Secure), the normally-closed side of the relay is the secure side. (The auxiliary relay polarity will change as soon as saved, a credential is not required.)	Normally Closed (Secure)
	Keys Buffered		4
	Reader 1 Facility Code		1
	Reader2 Facility Code		1

CT5000

	Property	Description
VIEW Tab	Date & Time	Current date and time. Initialized/set by the HHD.
	General Properties	
	Lock Name	The name of the CT5000. Set by the door file programmed into the CT5000.
	Model	Model number of the CT5000 connected to the HHD.
	Max Users	Number of Users supported by the CT5000.
	Max Audits	Number of audits supported by the CT5000.
	Power Status	Current voltage level of the Coin Cell battery.
	CT5000	
	Serial Number	Serial number that uniquely identifies the CT5000.
	Manufacture Date	Date the CT5000 was manufactured.
	Days Since Installed	Used for warranty purposes; marks the beginning of the CT5000 functional life.
	Firmware Version	Version of the current firmware file. Automatically updated when new firmware file is loaded.
	Hardware Version	Current version of the printed circuit main board.
	Bootloader Version	Version of the current bootloader. Allows new firmware to be loaded.

CT5000

	Property	Description	Default
	Lock Type	Classroom: Unlocks when a credential is presented and then automatically locks after the relock delay has expired. The CT5000 can only be Classroom Type.	Classroom
	PIN Length	Maximum number of digits in the user PIN. Range of 3 to 6 digits.	6
	Ignore Keypad	If checked, key entry codes are ignored.	Disabled
	Relock Delay	Amount of time before the CT5000 relocks after being unlocked by a user presenting a valid credential or the Request to Exit being released.	3 seconds
	CT5000-Input Request to Exit: Active Open/Active Closed	This sets the polarity of the Request To Exit signal into the CT5000. Default is when the switch is closed and the CT5000 reads and reports a Request to Exit.	Active close
	CT5000-Input Reader Tamper 1: Active Open/Active Closed	This sets the polarity of the Reader 1 Tamper signal into the CT5000. Default is when the switch is closed and the CT5000 reads and reports a Reader 1 Tamper.	Active close
	CT5000-Input Reader Tamper 2: Active Open/Active Closed	This sets the polarity of the Reader 2 Tamper signal into the CT5000. Default is when the switch is closed and the CT5000 reads and reports a Reader 2 Tamper.	Active close
	Door Position Switch (DPS): Installed	If unchecked, the Door Position Switch (DPS) is disabled and the Door Prop Delay, Anti-Tailgate, Request to Exit Clears Alarm, and Alarm are also disabled. By default, the CT5000 assumes there is no Door Position Switch (DPS) connected.	Disabled
EDIT Tab	Door Position Switch (DPS): Active Open/Active Closed	This sets the polarity of the Door Position Switch (DPS) signal into the CT5000 (Open or Closed). Default is when the switch is closed and the CT5000 reads and reports the door closed.	Active Open
	Door Prop Delay	The Prop Delay setting is the time to allow the door to be held open before the alarm relay triggers the alarm.	30 seconds
	Door Prop Delay: Enabled/Disabled	When enabled, the alarm relay will activate after the door has been open more time than the number of seconds specified in the Door Prop Delay time.	Disabled
	Anti-Tailgate	Anti-Tailgate is designed to automatically relock the door when the door re-closes, no matter how much time is left on the relock delay (requires a Door Position Switch).	Disabled
	Request to Exit Clears Alarm	During an alarm event, enabling request to exit disables the alarm.	Disabled
	Alarm Relay: Normally Open (Secure) Normally Closed (Secure)	When Normally-closed (Secure), the normally-closed side of the relay is the secure side. (The alarm relay polarity will change as soon as saved, a credential is not required.)	Normally Closed (Secure)
	Aux Relay: Normally Open (Secure) Normally Closed (Secure)	When Normally-closed (Secure), the normally-closed side of the relay is the secure side. (The auxiliary relay polarity will change as soon as saved, a credential is not required.)	Normally Closed (Secure)
	Strike Relay: Normally Open (Secure) Normally Closed (Secure)	When Normally-closed (Secure), the normally-closed side of the relay is the secure side. (Needs to read a valid credential before changing the relay polarity.)	Normally Closed (Secure)
	Coin Cell Nuisance Delay		Enabled (checked)

CO-Series Locks

Supported Locks

All chassis for the following models are supported.

CO-Series Locks

CO-200

CO-220

CO-250

This function works with CO-Series devices only.

The HHD will use a default Coupling Password (123456) when coupling with a device. The Coupling Password should be changed to provide increased security for your locks. See [Coupling Password](#) on page 18 for more information.

If a device is not in Coupling mode, SUS will display a device specific message with instructions for placing the device into Coupling mode.

Couple HHD to Lock

CO-Series locks can be coupled, or authenticated, with the HHD. This provides enhanced security by ensuring that the lock will only communicate with HHD to which it has been coupled. Once the lock has been coupled, the coupling password is passed to the device from the HHD during programming. Each lock will retain only one coupling password; therefore, only one HHD can be coupled with the lock.

- ➔ HHDs with the same coupling password can program the same devices. Each HHD with a different coupling password must be coupled with each device it will program.

 - 1 Connect the HHD to the lock using the HH-USB cable.
 - 2 Insert the mechanical key into the lock. Then rotate and hold the key.
 - 3 Continue holding the key and press the Schlage button three (3) times. Then release the key.
 - 4 On the HHD, select **Device Options**.
 - 5 On the HHD, select **Couple HHD to Device**.
 - 6 When Coupling is successful, a message will be displayed on the screen.

Program a Lock

- 1 Connect the HHD to the lock or controller and establish communication between the HHD and the device.
- 2 Select **Device Options**.
- 3 Select **Program Lock**.
- 4 Select the door file that should be associated with the lock or controller.
 - ➔ Door files are downloaded to the HHD when synchronized with the access control software.
- 5 Select **OK**.

Collect Audits

Collecting audits on the HHD does not delete the audits from a lock.

Collected audits will be transferred from HHD to your Access Control Software the next time they are synchronized.

When Auto Update is enabled, as soon as the Schlage button is pressed twice and the communication with the Schlage Utility Software starts, the lock will automatically:

- update lock's date/time
- collect audits
- update access rights

When Manual Update is enabled, follow the steps below to collect audits and update the lock access rights.

→ See [Update Mode](#) on page [18](#) for more information.

Collect Audits when Date/Time and Lock Access Rights are Up-to-Date

- 1 Confirm HHD is connected to lock.
 - See [Connect the Handheld Device to the PC](#) on page [13](#) for more information.
- 2 Double-click the displayed name of the connected lock.
- 3 The audit collection will begin.
 - If no previous audit exists, skip to step 7.
- 4 If a previous audit exists, a message will appear asking to overwrite previous audit. Click **YES** to override audits and skip to step 7.
- 5 Click **NO** if you do not want to override the audit.
- 6 Acknowledge the message advising to synchronize the lock with system software. Audit collection will be stopped.
- 7 A progress indicator will be displayed while the audit is being collected. A message will be displayed once the process is complete.

Collect Audits when Date/Time and Lock Access Rights are Not Up-to-Date

- 1 Confirm HHD is connected to lock.
 - See [Connect the Handheld Device to the PC](#) on page [13](#) for more information.
- 2 Double-click the displayed name of the connected lock.
- 3 When asked to update date and time of the device, click **YES**. A progress indicator will be displayed while date and time is being updated.
- 4 A message will appear to confirm the successful update.
- 5 The audit collection will begin. A progress indicator will be displayed while the audit is being collected.
- 6 The access rights update will begin. A progress indicator will be displayed while lock is being updated.
- 7 A message will be displayed once the process is complete.

View Properties

- 1 Connect the HHD to the lock or controller.
- 2 Select **Device Options**.
- 3 Select **Properties** for the connected device.
- 4 The **View** tab will be displayed.
 - See [Lock Properties](#) on page [60](#) for more information.

Edit Properties

- 1 Connect the HHD to the device.
- 2 Select **Device Options**.
- 3 Select **Properties** for the connected device.
- 4 Select the **Edit** tab.
- 5 Edit the properties as desired.
 - See **Lock Properties** on page **60** for more information.
- 6 Select **Save** before exiting the tab.

View Reader Properties

- 1 Connect the HHD to the device.
- 2 Select **Device Options**.
- 3 Select **Properties** for the connected device.
- 4 Select the **Reader** tab.
 - See **Lock Properties** on page **60** for more information.

Edit Reader Properties

- 1 Connect the HHD to the device.
- 2 Select **Device Options**.
- 3 Select **Properties** for the connected device.
- 4 Select the **Reader** tab.
- 5 Edit the properties as desired.
- 6 Select **Save** before exiting the tab.
 - See **Lock Properties** on page **60** for more information.

Update Firmware

- See **AD-Series and CO-Series Device Firmware Update** on page **77** for more information.

Lock Properties

CO-200/220/250

	Property	Description
	Date & Time	Current date and time. Initialized/set by the HHD.
	General Properties	
	Lock Name	The name of the Lock. Set by the door file programmed into the lock.
	Model	Model number of the device connected to the HHD.
	Max Users	Number of Users supported by the lock (CO-200/220)
	Max Void List	Number of void users supported by the lock (CO-250)
	Max Audits	Number of Audits supported by the lock.
	Power Status	Current voltage level of the AA and Coin Cell batteries.
	Main Lock	
VIEW Tab	Serial Number	Serial number that uniquely identifies the lock.
	Manufacture Date	Date the lock was manufactured.
	Days since Installed	Used for warranty purposes; marks the beginning of the lock's functional life.
	Firmware Version	Version of the current firmware file. Automatically updated when new firmware file is loaded.
	Hardware Version	Current version of the printed circuit main board.
	Bootloader Version	Version of the current bootloader. Allows new firmware to be loaded.
	Credential Reader	
	Reader Type	Type of Reader installed: Keypad, MagInsert, MagSwipe, Proximity, and Keypad Variations

CO-200/220/250

	Property	Description	Default
EDIT Tab	Lock Type	<p>Classroom Security (CO-220 Only): Allows lock to be placed into secure lockdown by the a paired fob. Once in lockdown, only a Passthrough credential can be used to gain access.</p> <p>Office: Unlocks when a credential is presented and then automatically locks after the relock delay has expired. To keep the door unlocked, push the button on the inside. The button will momentarily illuminate green. To return the lock to the locked state, push the button again or present a credential to the outside.</p> <p>Privacy: To initiate the Privacy function, with the door closed, push the button on the inside of the door. This prevents normal credentials from opening the door from the outside.</p> <p>The lock will go back to its normal state when the button is pushed again or when the door position switch indicates that the door has opened.</p> <p>When using a Mortise Deadbolt, extending the deadbolt from the inside lights a red LED on the inside trim and initiates the Privacy function which prevents normal credentials from opening the door from the outside. The lock can always be opened using a Pass-Through credential or mechanical key in case of emergency.</p> <p>Storeroom: Lockset is normally secure. Inside lever always allows free egress. Valid Toggle credentials may be used to alternate (toggle) the state of the lock between passage (unlocked) and secured (locked). Unlocks when a normal credential is presented and then automatically locks after the relock delay has expired.</p>	Set by the Factory
	PIN Length (CO-200/220 only)	Maximum number of digits in the user PIN. Range of 3 to 6 digits.	6
	Allow Privacy Mode Override (CO-250 only)	When enabled, allows cards override a lock that has been placed in privacy mode. When disabled, only cards specifically assigned to this door will have access.	Disabled
	Ignore Keypad	If checked, key entry codes are ignored.	Disabled
	Record Lock/Unlock ¹	If checked and supported by the system software, will record an audit event when the Inside Push button is pressed.	
	Disable Interior Button LED ¹	If checked, interior button LED blinking is disabled.	Enabled (checked)
	Battery Fail Mode	Lock state set when battery fails. As-Is, Secure/Locked, Unsecure/Unlocked	As-Is
	Coin Cell Battery Nuisance Delay	Lock state set after coin cell battery replacement. If unchecked, nuisance delay is disabled.	Disabled (unchecked)
	Relock Delay	Amount of time before the lock relocks after being unlocked by a user presenting a valid credential.	3
ADA Delay (CO-250)	Amount of time before the lock relocks after being unlocked by a user who is flagged as handicapped and presenting a valid credential. Can be changed in the access control system.	30	
READER Tab	Property	Description	Default
	Prox in Use	Proximity credential card types allowed. Selections: HID/KantechIO, GE/CACY, AWID	ALL selected
	Mag Track in Use	Magnetic card track that access data is to be read from. Track 1, 2 or 3 (Track 1 not configurable for CO-200)	Track 2
	Enable Low Power Wake-Up	Active when Mag Track 1 or 3 is selected in "Mag Track in Use". By enabling Low Power Wake-Up and recording data on track 2, this option will allow longer battery life.	Enabled
Beeper	Indicates if the Beeper is on or off.	ON	

1. This feature is not available on the CO-220 Safe School Lock.

Legacy Locks and Controllers

Supported Legacy Locks		Supported Controllers	
KC2	BE367	Legacy PIM	CT500/1000 Controller
CM		WRI*	CL Campus Lock Controller
CL		WPR*	
		WPR2*	
		WSM*	

* These devices cannot be configured directly. They are configured through the Legacy PIM.

Program a Lock or Controller

All legacy devices use the serial connection type. Be sure to change the connection type option when connecting to a legacy device. See [Connection Type](#) on page 17 for more information.

See [Start the Schlage Utility Software](#) on page 15 and [Connecting the Handheld Device on page 20](#) for more information.

- 1 Connect the HHD to the lock using the HH-Serial Cable and CIP if using the BM150. Both the BM-150 and BM-170 can also use the HH-2PIN Serial Cable.
 - See [Connecting the Handheld Device](#) on page 20 for more information.
- 2 Select **Device Options**.
- 3 Select **Program Lock**.
- 4 Select the door file that should be associated with the lock.
 - Door files are downloaded to the HHD when synchronized with the access control software.
- 5 Select **OK**.
- 6 Wait for the screen asking for the programming credential. Then present the programming credential to the lock.
 - The lock will flash red and green alternating several times, indicating it has entered programming mode.
 - Consult the lock user guide that came with your lock for more information about programming mode.
- 7 Select **OK**. Lock programming will begin.

Collect Audits and Update a Lock

All legacy devices use the serial connection type. Be sure to change the connection type option when connecting to a legacy device. See [Connection Type](#) on page 17 for more information.

Collecting audits on the HHD does not delete the audits from a lock.

Collected audits will be transferred from HHD to your Access Control Software the next time they are synchronized.

When Auto Update is enabled, as soon as the Schlage button is pressed twice and the communication with the Schlage Utility Software starts, the lock will automatically update lock's date/time, collect audits and update access rights.

When Manual Update is enabled, follow the steps below to collect audits and update the lock access rights.

→ [See Update Mode on page 18 for more information.](#)

Collect Audits when Date/Time and Lock Access Rights are Up-to-Date

- 1 Connect the HHD to the lock using the HH-Serial cable, CIP and serial connection type, if using the BM150.
- 2 Both the BM-150 and BM-170 can also use the HH-2PIN Serial Cable.
→ [See Connecting the Handheld Device on page 20 for more information.](#)
- 3 Double-click the displayed name of the connected lock.
- 4 The audit collection will begin.
→ If no previous audit exists, skip to step 7.
- 5 If a previous audit exists, a message will appear asking to overwrite previous audit. Click **YES** to override audits and skip to step 7.
- 6 Click **NO** if you do not want to override the audit.
- 7 Acknowledge the message advising to synchronize the lock with system software. Audit collection will be stopped.
- 8 A progress indicator will be displayed while the audit is being collected. A message will be displayed once the process is complete.

Collect Audits when Date/Time and Lock Access Rights are Not Up-to-Date

- 1 Confirm HHD is connected to lock.
→ [See Connecting the Handheld Device on page 20 for more information.](#)
- 2 Double-click the displayed name of the connected lock.
- 3 When asked to update date and time of the device, click **YES**.
- 4 When asked for a valid programming credential, present the credential and then click **OK**. A progress indicator will be displayed while date and time is being updated.
- 5 A message will appear to confirm the successful update.
- 6 When asked for a valid programming credential (second time), present the credential and then click **OK**. The audit collection will begin. A progress indicator will be displayed while the audit is being collected.
- 7 The access rights update will begin. A progress indicator will be displayed while lock is being updated.
- 8 A message will be displayed once the process is complete.

All legacy devices use the serial connection type. See [Connection Type](#) on page 17 for more information.

All legacy locks require the CIP if using the BM150. Both the BM-150 and BM-170 can also use the HH-2PIN Serial Cable. See [Connecting the Handheld Device](#) on page 20 for more information.

All non-lock legacy controllers require the null converter (PIMWA-CV). See [Connecting the Handheld Device](#) on page 20 for more information.

View Properties

- 1 Connect the HHD to the lock or controller.
- 2 Select **Device Options**.
- 3 Select **Properties** for the connected device.
- 4 The **View** tab will be displayed.
→ See [Lock Properties](#) on page 65 for more information.

Edit Properties

- 1 Connect the HHD to the lock or controller.
 - See [Connecting the Handheld Device](#) on page 20 for more information.
- 2 Select **Device Options**.
- 3 Select **Properties** for the connected device.
- 4 Select the **Edit** tab.
- 5 Edit the properties as desired.
 - See [Lock Properties](#) on page 65 for more information.
- 6 Select **Save**.
- 7 Wait for the screen asking for the programming credential. Then present the programming credential to the lock.
 - The lock will flash red and green alternating several times, indicating it has entered programming mode.
 - Consult the lock user guide that came with your lock for more information about programming mode.
- 8 Select **OK**. Lock properties will be saved.

Update Firmware

Consult the directions that came with your lock for information about entering programming mode.

- 1 Connect the HHD to the device you want to update.
 - See [Connecting the Handheld Device](#) on page 20 for more information.
- 2 Select **Device Options**.
- 3 Select **Firmware Update**.
- 4 Select the desired firmware file from the list.
 - Firmware updates are available at www.schlage.com/support to be downloaded to the computer that synchronizes with the HHD. See [Appendix B: Device Firmware Update on page 77](#) for details on how to obtain firmware files online and update to the HHD.
- 5 Select **OK** at the bottom of the screen.
- 6 Wait for the screen asking for the programming credential. Then present the programming credential to the device.
 - The lock will flash red and green alternating several times, indicating it has entered programming mode.
 - Consult the lock user guide that came with your lock for more information about programming mode.
- 7 Select **OK** to proceed when prompted.
- 8 A progress indicator will be displayed during the firmware update. A message will be displayed briefly once the firmware update is complete.
 - Updating Lock firmware will require the user to reset the lock before proceeding. See [Appendix C: Change Lock Class](#) on page 85 for more information.

Link a Door to a Legacy PIM

- 1 Connect the HHD to the Legacy PIM. Both the BM150 and the BM-170 with HH-Serial Cable and with the null converter (PIMWA-CV) attached can be used.
 - See [Connecting the Handheld Device](#) on page 20 for more information.
- 2 Select **Device Options**.
- 3 Select the **PIM Properties** button.
- 4 Select the **Link** tab.
- 5 Select the door you want to link from the **Door** drop-down list.
- 6 Select the **Link** button.
 - Perform the necessary steps to place the appropriate wireless lock or controller into linking mode. See the user guide that came with the device for more information.

Diagnostics

Test Mode can be used for troubleshooting.

- 1 Connect the HHD to the controller.
 - See [Connecting the Handheld Device](#) on page 20 for more information.
- 2 Select **Device Options**.
- 3 Select **Diagnostics**.

Lock Properties

Property	Description	Editable?
Lock Name	Name of the Lock Can be edited in the access control system.	No
Firmware Version	Version of the current firmware file Automatically updated when a new firmware version is loaded.	No
Date & Time	Current date and time Lock setting	Yes
Relock Delay	Amount of time before the lock relocks after being unlocked by a user presenting a valid credential	Yes
Prop Delay	Amount of time a door can be open before the prop delay alarm is activated	Yes

Troubleshooting

General Troubleshooting

If you are having trouble with the SUS and/or the handheld device, please check the following before contacting customer support:

Battery:

- 1 Make sure the handheld device has been charged.
- 2 Make sure the batteries in the lock are not depleted.

Cable:

- 3 The programming cable must be properly connected to the lock and the handheld device.
- 4 Make sure you are using the programming cable that came with the handheld device.
- 5 When programming a legacy device using the CIP, the CIP must be inserted in the correct orientation. See [Connecting the Handheld Device](#) on page 20 for more information.

Handheld Device (HHD):

- 6 Make sure you are using the correct connection type. See [Connection Type](#) on page 17 for more information. Both the BM-150 and the BM-170 can use serial communications with locks and controllers using the HH-Serial Cable and with the null converter (PIMWA-CV) attached with the Legacy PIM.
- 7 If the HHD is not responding to button presses or screen taps, be sure that the HOLD slider switch on the left side of the HHD (BM-150 ONLY), is not in the HOLD position.
- 8 If the HHD is not responding to screen taps, check to see if the Unlock selection is available at the bottom of the START screen. If the Unlock selection is present, tap on it to unlock the
- 9 If the HHD or SUS application appears to be hung up and not operating properly, RESET the (BM-150) HHD by removing the battery compartment cover and carefully press the RESET button in the lower right-hand corner. To RESET the (BM-170) press the RESET button located on the lower right-hand corner of the case.

PC and HHD:

- 10 If the HHD will not connect and synchronize with the PC, be sure the SUS application is not running and the PC's USB port is not in use by other applications.
- 11 If synchronizing with your PC takes a long time, be sure that the My Document folder does not have large files in it.
- 12 If you do not have firmware files available in the [Update Firmware](#) menu, be sure the files have been copied to the HHD root directory My Device.

System:

- 13 If the SUS is not running properly or is intermittent, be sure the HHD has adequate memory available.
- 14 Communication between PIM400 and Access Control Panel will not occur if the HHD is connected to either the AD-400 or the PIM400.
 - Disconnect the HHD from hardware prior to testing system.
- 15 If the BM-170 goes to sleep while connected to a CO Lock, wake the device up and press the Schlage button four (4) times to resume communication.

Error Codes

No.	Error	Solution
E100	Enter a valid password	No password was entered. Enter the correct password.
E101	Incorrect password	The password entered was incorrect. Enter the correct password.
E102	Incorrect password entered three times. Wait for 30 seconds before next retry	An incorrect password was entered three times. Wait thirty (30) seconds. Then enter the correct password.
E103	The old password is incorrect	When attempting to change the password, the old password entered was incorrect.
E104	Password field cannot be left blank	When attempting to change the password, no password was entered.
E105	Password must be at least 4 characters	When attempting to change the password, the password entered was too short.
E106	Passwords do not match	When attempting to change the password, the second password entered did not match the first password entered.
E107	Old password and new password are identical	When attempting to change the password, both passwords are the same. The new password must be different.
	No Device Connected	The Options menu was tapped when no lock was connected to the HHD. Connect the HHD to a device and try again.
E201	This device is not connected	A device name, other than the device to which the HHD is currently connected, was selected and then the Options menu item was tapped. Options can be viewed only for the lock that is currently connected.
E202	Unrecognized device connected or incompatible SUS version. Please visit www.schlage.com/support to download the latest SUS version and try again	SUS is unable to recognize this device. The version of SUS on the handheld is currently incompatible with this device. Please visit www.schlage.com/support to download the latest SUS version and try again.
E300	Collecting audit failed	The HHD was disconnected from the lock before audit collection was complete. The HHD must remain connected to the lock until collection is complete.
E301	Synchronizing lock data failed	The HHD was disconnected from the lock before synchronization was complete. The HHD must remain connected to the device until synchronization is complete. OR No valid programming credential was presented to the lock. A valid programming credential must be presented before the device can be programmed.
E302	Updating lock's date and time failed	The HHD was disconnected from the lock before date/time update was complete. The HHD must remain connected to the device until date/time update is complete. OR No valid programming credential was presented to the lock. A valid programming credential must be presented before the date/time can be updated.
E303	Your HHD is not authenticated to perform this action. Couple HHD with the device to authenticate	This message appears when the device is not coupled with the HHD and an action requiring authentication was performed (feature change, firmware update, lock synchronization, etc.).

Error Codes

No.	Error	Solution
E304	Retrieving lock properties failed	The HDD was disconnected from the lock before the Retrieving Properties process was complete. The HDD must remain connected to the lock until the process is complete.
E305	Retrieving PIB properties failed	The HDD was disconnected from the PIB300 before the Retrieving Properties process was complete. The HDD must remain connected to the PIB300 until the process is complete.
E306	Retrieving PIM properties failed	The HDD was disconnected from the PIM400/401 or Legacy PIM before the Retrieving Properties process was complete. The HDD must remain connected to the PIM400/401 or Legacy PIM until the process is complete.
E307	Retrieving door properties failed	The HDD was disconnected from the Door before the Retrieving Properties process was complete. The HDD must remain connected to the Door until the process is complete.
E400	Data files for French language are missing	When attempting to change the language to French, the French language files cannot be found. Contact customer support.
E401	Data files for Spanish language are missing	When attempting to change the language to Spanish, the Spanish language files cannot be found. Contact customer support.
E500	Please set the Relock delay and Prop delay	The relock delay and prop delay must be greater than zero (0). Change the delay(s) to a value greater than zero (0).
	Lock1 and Lock2 address cannot be identical	The Save menu item was tapped but no values were changed. Change at least one value, or tap back to cancel.
E502	Saving properties failed	The HDD was disconnected from the lock before the saving properties function was complete. The HDD must remain connected to the lock until the saving properties process is complete. OR No valid programming credential was presented to the lock. A valid programming credential must be presented before the properties can be saved.
E503	The Unique ID should be in range 0 - 65535	The PIM400 or Legacy PIM address entered was greater than 65535. Enter a value less than 65535 and try again.
E504	The Unique ID should be in range 1-65534	The PIM400 or Legacy PIM address is incorrect. Enter a value less than 65535 and try again.
E505	The RS485 address should be in range 0- 254	The RS485 address entered was greater than 254. Enter a value less than 254 and try again.
E506	The Relock Delay value should be in range 0- 255	The Relock Delay entered was greater than 255. Enter a value less than 255 and try again.
E507	Reserved address 170 cannot not be used for RS485 address	The RS485 address entered is incorrect. Enter a value less than 254 and different than 170.
E508	Difference between high door and low door cannot be equal or greater than 16	While setting the addresses of the Low and High doors make sure that the difference between both is less than 16.
E509	High door cannot be lesser than low address	The address of the High door MUST be greater than the Low door.

Error Codes

No.	Error	Solution
E510	The ADA Delay value should be in range 0- 255	The ADA Delay entered was greater than 255. Enter a value less than 255 and try again.
E600	Please select the firmware file	No firmware file was selected before the OK menu item was tapped when attempting to update the lock's firmware. Select a firmware file and try again.
E601	Updating firmware failed	<p>The HDD was disconnected from the lock before the firmware update was complete. The HDD must remain connected to the lock until the firmware update is complete.</p> <p>No valid programming credential was presented to the lock. A valid programming credential must be presented before the firmware update can be done.</p> <p>SUS may need to be updated in order to perform firmware updates to this device. Please check www.schlage.com/support for the latest version.</p>
E602	No files to select	The HDD does not have any files to select from or they were put in the incorrect folder.
E603	File integrity check failed	While updating Firmware or Programming a lock, the SUS software detected that the file being used is corrupted. Download/Create the file again and upload it into the HDD.
E604	Cannot open file	
E605	Cannot read file	
E606	Invalid file	
E607	Please select the lock class file	While attempting to change a lock class, inside the Firmware Package Screen – no selections were made. Select a lock class and try again.
E700	Please select the door	While attempting to program a lock, no door was selected. Select a door and try again.
E701	Programming lock failed	<p>The HDD was disconnected from the lock before the lock setup was complete. The HDD must remain connected to the lock until the lock setup is complete.</p> <p>No valid programming credential was presented to the lock. A valid programming credential must be presented before the lock can be set up.</p>
E702	The door file is invalid due to incorrect data present; for example, blank lines. This can occur for multiple reasons, including manually editing the door file.	Use SMS to regenerate the door file & load the new door file into the SUS. Then retry programming.
E703	Door file contains invalid data for the AD200 lock model. Verify the correct lock and door files are selected or regenerate the door file and try again. Click OK to continue.	The Doorfile used contains IButton Data. This data is not valid for an AD200 Lock. Ensure the correct door/doorfile is selected or regenerate the doorfile.
E704	The selected Door file contains format errors. Click OK to Continue or Cancel to exit and try again using a new door file.	The doorfile contains errors that may interfere with normal operation. Programming is allowed to proceed if OK is selected. It is recommended that the doorfile be generated again by the access software in order to ensure the expected function of the lock.

Error Codes

No.	Error	Solution
E800	Device is not in coupling mode	<p>AD series: Hold down the Interior Push Button and press the Tamper switch (sw1) 3 times.</p> <p>PIM400/PIB300 devices: Hold down LINK1 switch (s2) and press LINK2 switch (s3) 3 times.</p> <p>CO Series: Rotate mechanical key and hold while pressing Schlage button 3 times.</p> <p>WRI400/CT5000 devices: Hold down the SCHLAGE switch (s1) and press the LINK switch (s2) 3 times.</p> <p>WPR400: Hold down the IPB switch (s2) and press the TMP switch (s3) 3 times.</p> <p>While trying to couple the HDD with the device, the message pops up when the connected device was not in coupling mode. Follow the instructions to put the connected device in coupling mode and try again.</p>
E801	Lock not responding correctly	<p>Verify cable is properly connected to lock.</p> <p>If trying to program, verify Program Mode has been entered properly.</p> <p>If programming a KC-2 Deadbolt for the first time be sure the latch bolt is retracted.</p> <p>While communicating with the lock, the SUS has detected some problems, follow the presented instructions to correct the problem.</p>
E802	Device does not support this action	
E810	Saving from device failed.	Please try again.
E900	Cannot open or read file	SUS was not able to read this file. If this was a firmware package, SUS is currently incompatible with this firmware package. Please visit www.schlage.com/support to download the latest SUS version and try again.

Remove the Schlage Utility Software

This process will remove the Schlage Utility Software from the handheld device.

- 1 On your handheld device, tap the **Start** menu.
- 2 Select **Settings**.
- 3 Select the **System** tab.
- 4 Select the **Remove Programs** icon.
- 5 Select to select the **Schlage Universal Software** in the list.
- 6 Select the **Remove** button.
- 7 Select the **Yes** button.
 - ➔ To reinstall the SUS, see [Install/Update Schlage Utility Software on page 13](#).

Glossary

BCD

Acronym for Binary Coded Decimal, an encoding method for representing decimal numbers where each digit is represented by four bits.

CAC

Acronym for Common Access Card, a U.S. Department of Defense smart card issued as standard identification, and for access to computers, networks and some facilities.

Cache Mode

How the reader will handle stored card information if there is loss of communication to its controller.

Card Conversion

Card data filters and converters that provide data that can be accepted by the access control system.

CM Lock

A Computer Managed offline lock, for example the Schlage CM 5500 series.

CSN

Acronym for the Card Serial Number, a unique, unencrypted identification number contained on the integrated chip in each smart card.

DCS

Acronym for Dynamic channel switching - can be selected to decrease the chance of interference but will decrease battery life.

Delay

The idle time between subsequent queries. - Shorter delays may reduce latency. - Longer delays may enhance battery life.

Door Prop Delay

The time allowed between opening a Door and closing it. If the Door is open longer than the Door prop delay an alarm is released. The delay can be set individually for each Door and is programmed through the program files.

Extend Unlock

This setting is required to respond to scheduled unlocks from an access control panel.

Fail Safe/Secure

The condition of a lock or latch when a loss of RF communications occurs between the PIM400/401 or Legacy and an access point.

FASC-N

Acronym for Federal Agency Smart Credential Number, an identifier used on all government issued credentials.

FC Mode

Allows access by Facility (Site) code.

First

The first query an access point makes to a PIM400/401 or Legacy PIM occurs immediately following a card swipe. - "First" is the amount of time, in milliseconds, an access point should wait before making its second query to a PIM400/401 or Legacy. This setting should be slightly greater than the fastest response time from the access control panel or host. This optimizes battery life and system performance.

GUI

Acronym for Graphical User Interface.

Heartbeat

The time interval that access points communicate to PIM400/401 or Legacy PIM when there is no activity. Affects battery life.

Hi Lo Output

These settings control the PIM400/401-TD2 open collector outputs sent to an access control panel on detection of Request-to-Exit (RTX), Door Position Switch (DPS), and Trouble. The WPIM switches these signals between an open collector and ground state.

Latch Type

Configuration of an access point depending on lock or latch type issued or used.

Mode

Configuration of an access point for standard operation or for factory testing.

No Purge

Reader will remember the first 20 cards swiped for degraded mode access.

PIM

Acronym for Panel Interface Module.

PIV

Acronym for Personal Identification Verification, refers to control and security standards set by the National Institute of Standards and Technology (NIST) for Federal employees and long-term contractors.

Relatch Time

The interval between the unlocking and relocking of an access point. Controlled by the access point, not the host system.

Relock delay

The time span from unlocking a lock after presenting a Credential until relocking. The relock delay can be set for each Door individually between 1 and 254 seconds. The relock delay setting is transferred to the lock through the program file.

TSA

Acronym for Transportation Security Administration.

TSM

Acronym for Transaction Status Message.

TWIC

Acronym for Transportation Worker Identification Credential.

Request to Exit

Whenever a Door is opened from the safe side a request to exit is required. In the simplest version this means operating a mechanism that unlocks the door (for example turning the doorknob). Most electronic locks use a switch to detect a request to exit. This can be a passive infrared sensor, a push button, an electronic exit bar, or the doorknob contact itself. This switch has either a normally open or a normally closed contact. Based on this configuration the system has to be set up correctly, otherwise a request is permanently reported unless someone activates the switch.

Retry

The maximum number of times an access point queries a PIM400/401 or Legacy PIM before the access point goes back to sleep. The number of retries should be slightly greater than the longest response time from the access control panel or host.

Rxt

Determines whether the access point module queries for unlock authorization on a Request to Exit activation.

Rxt Sift

Determines whether a WA56XX or WA993 reports Request to Exit activations in unlocked state.

UID

Acronym for the Unique Identifier, a unique, unencrypted identification number contained on the integrated chip in each smart card. (May also be referred to as CSN.)

WAPM

Acronym for Wireless Access Point Module.

Appendix A: SUS Update Guide

Follow the steps listed on this guide to update your SUS software to the latest version provided.

- 1 Browse to www.schlage.com/support.
- 2 Click the **Access Control Software & Control Panels** tab.
- 3 Click **Schlage Utility Software**.
- 4 Click **View** under the **Firmware & Software** column
- 5 Click **Schlage Utility Software Download for HHD** and save the "Schlage Utility Software Setup File.zip" file to your computer.

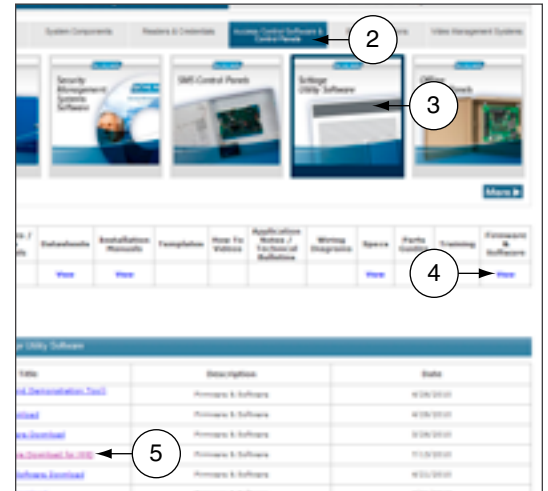

- 6 Turn ON the Hand Held Device (HHD) and connect it to the computer.

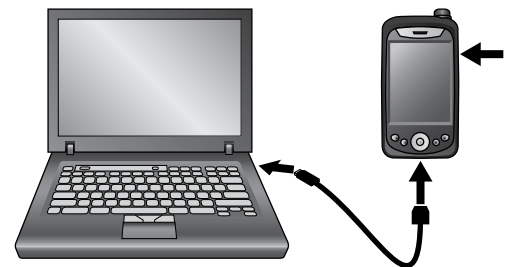

- 7 Open "Schlage Utility Software Setup File.zip" (see step 5) and double-click **Schlage Utility Software Setup Ver X.X.X.exe** (version number may vary). Then click **Run**.

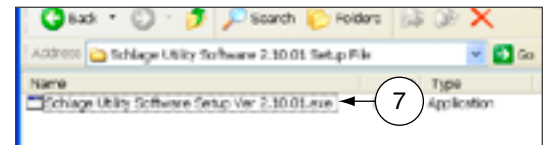

- 8 Click the **Next** button when the welcome screen appears.

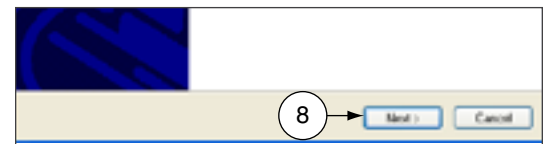

- 9 Click the **Next** button after reading the information screen.



- 10 Click the **Install** button to start installation.

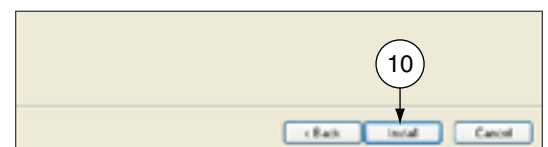

- 11 If the SUS is already installed a message will warn you about the upgrade, click the **Yes** button to continue. The installation will start.

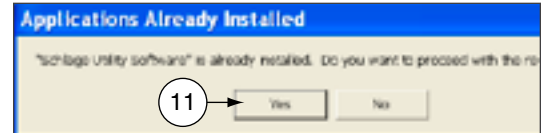

- 12 Click the **OK** button, when prompted to check your Hand Held Device (HHD).

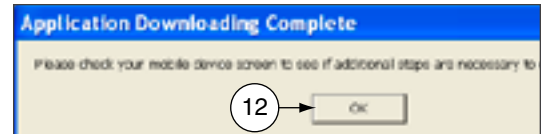

- 13 Click the **Finish** button to complete the first stage, and then check the HHD for the final step.

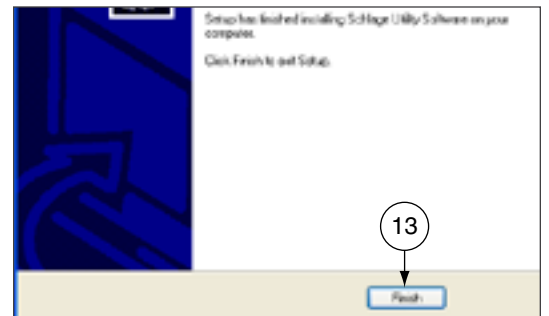

- 14 On the Hand Held Device (HHD) check if you received a message stating that the software is from an unknown publisher, click the **Yes** button to continue the installation or jump to the next step if you don't receive the message.

- 15 On the Hand Held Device (HHD) a prompt message will appear asking if you'd like to remove the previous version, click the **OK** button to continue. The installation will start on the Hand Held Device (HHD)

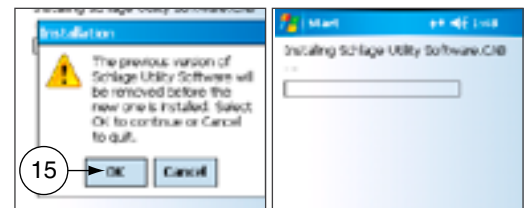

- 16 A screen prompting for the correct location to install the software will appear; Select: **\ProgramStore** and click **Install**. The installation will continue.

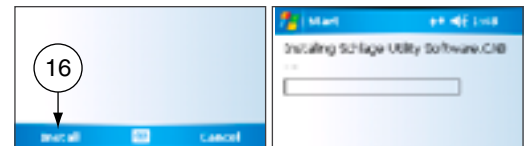

- 17 Click the **<OK>** button on the right top of the screen to close the successfully installed message.



- 18 Before launching the Schlage Utility Software on the HHD disconnect it from the computer.

- 19 On the HHD Go to **Start -> Programs** and double click on the **<Utility Software>** icon to start the Schlage Utility Software (SUS). You'll see a welcoming screen with the actual software version.

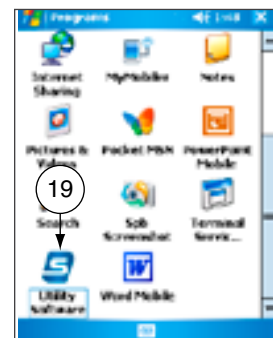

- ➔ Important note: The SUS and the HHD pairing passwords are back to their default values (123456). If your pairing password was different than the default, you would need to change it before trying to reconnect to your device.

- 20 Change the Coupling Password.

- ➔ See **Coupling Password** on page 18 for more information.

Appendix B: Device Firmware Update

AD-Series On-Line Devices: Over Network Reprogramming (ONR).

Supported Products

PIM400-485-RSI, PIM400-485-VBB, AD-300/301 when wired by RS-485 to the ACP, AD-400/401/402 when linked to a PIM400-485. Devices must have been updated to A.D.A.60 or later for ONR to be available.

This feature must be provided by the Access Control Software Partner. Talk to your Access Control Provider for more details.

AD-Series and CO-Series Device Firmware Update

Windows XP

Prerequisites

- ActiveSync should be installed on your PC.
 - ➔ See **Synchronization Software** on page 9 for more information.
- HHD should have a partnership with ActiveSync.
- HHD should be already coupled with AD-Series device to be updated.
 - ➔ See **“Couple HHD to Lock”** or **“Couple HHD to PIM400 or PIB300”** for more information.

- 1 Browse to www.schlage.com/support.
- 2 Click **View** under the **Firmware & Software** column
- 3 Click **AD Firmware Package - Tools & Docs** and save the “AD Firmware Pkg.zip” file to your computer.

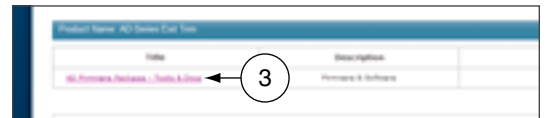

- 4 Turn on the HHD and connect it to the computer. The Microsoft ActiveSync window will automatically appear.

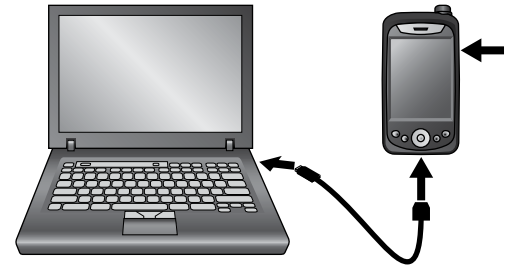

- 5 In the Microsoft ActiveSync window, click on the **Explore** button to open the HHD **Mobile Device** folder.

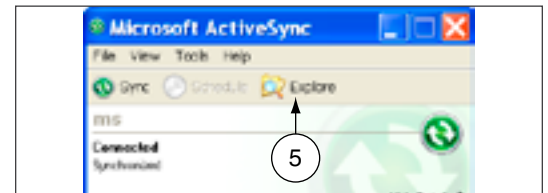

- 6 Double click on **My windows Mobile-Based Device** to go to the root directory of the HHD.



- 7 Copy the ".ffp" firmware file available inside the "AD firmware Pkg.zip" file (see step 3) and paste it inside the root folder **<My Windows Mobile-Based Device>**.

- 8 Wait for the HHD to synchronize.

- 9 Disconnect the HHD from computer.

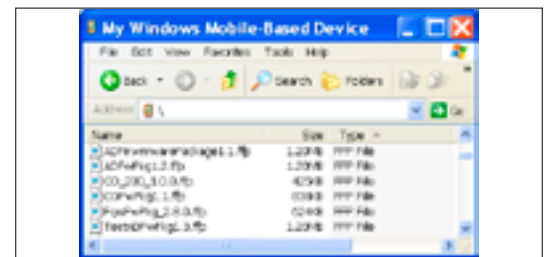

- 10 Go to the device and connect the HHD.

→ See **Connecting the Handheld Device** on page 20 for more information.

- 11 Start the Schlage Utility software.

→ See **Start the Schlage Utility Software** on page 15 for more information.

- 12 Login as a Manager.

→ See **Log in as a Manager** on page 16 for more information.

- 13 Click **Device Options** at the bottom of the screen.

- 14 Click **Firmware Update**.

- 15 Select the firmware package you would like to use and click **OK**.

- 16 A message asking for confirmation to start programming the firmware will appear. Click **YES**.

- 17 The updating process will begin. The device will then restart. After a few minutes, a message indicating the firmware update was successful will appear.

- 18 Click **OK**.

→ If the credential reader was changed, a factory default reset is recommended. See the user manual that came with the device for more information. **WARNING:** A factory default reset will delete all door information from the lock.

Windows 10, Windows 8, Windows 7 and Windows Vista

Prerequisites

- Microsoft Windows Mobile Device Center should be installed on your PC.
 - ➔ See [Synchronization Software](#) on page 9 for more information.
- HHD should have a partnership with Windows Mobile Device Center.
- HHD should be already coupled with AD-Series device to be updated.
 - ➔ See [“Couple HHD to Lock”](#) or [“Couple HHD to PIM400 or PIB300”](#) for more information.

- 1 Browse to www.schlage.com/support.
- 2 Click **View** under the **Firmware & Software** column.
- 3 Click **AD Firmware Package - Tools & Docs** and save the “AD Firmware Pkg.zip” file to your computer.

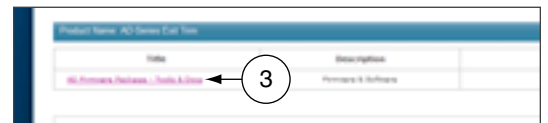
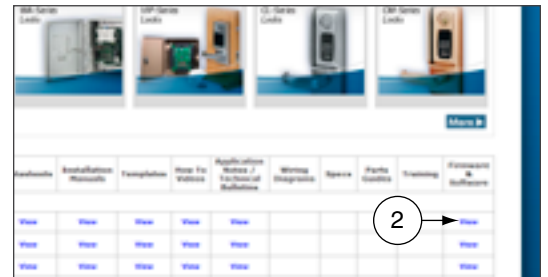

- 4 Turn on the HHD and connect it to the computer. The Microsoft Windows Mobile Device Center window will automatically appear.

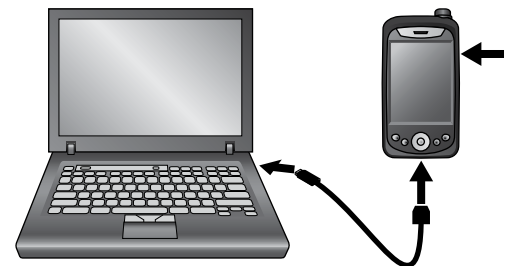

- 5 In the Microsoft Windows Mobile Device Center window, click on **File Management** and then **Browse the contents of your device** to open the HHD device contents.

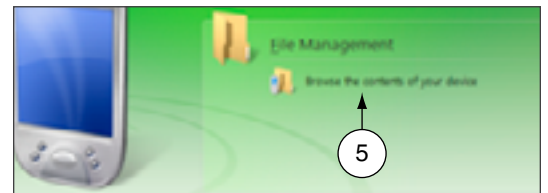

- 6 Double click on **** to go to the root directory of the HHD.

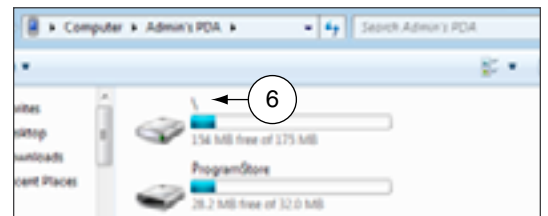

- 7 Copy the “.ffp” firmware file available inside the “AD firmware Pkg.zip” file (see step 3) and paste it inside the root folder (\).
- 8 Wait for the HDD to synchronize.
- 9 Disconnect the HDD from computer.

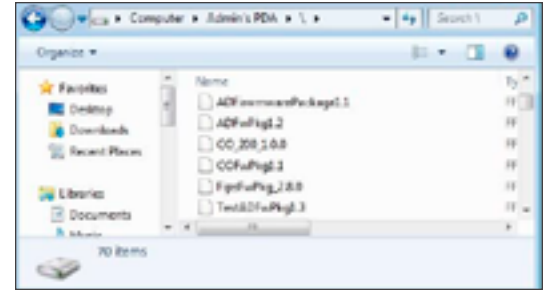

➔ NOTE: The SUS will prevent a user from reprogramming a device if batteries are too low and give the warning saying, “The voltage level to complete the firmware update is too low, you must replace the AA batteries and try again.” The battery threshold requirements are as follows:

CO locks	All locks	4.7V
AD locks running firmware older than AD.A.50	8 battery locks	8V
	4 battery locks	5.5V
AD locks running firmware AD.A.50 or greater	8 battery locks	7.2V
	4 battery locks	4.7V

- 10 Go to the device and connect the HDD.
 - ➔ See [Connecting the Handheld Device](#) on page 20 for more information.
- 11 Start the Schlage Utility software.
 - ➔ See [Start the Schlage Utility Software](#) on page 15 for more information.
- 12 Login as a Manager.
 - ➔ See [Log in as a Manager](#) on page 16 for more information.
- 13 Click [Device Options](#) at the bottom of the screen.
- 14 Click [Firmware Update](#).
- 15 Select the firmware package you would like to use and click **OK**.
- 16 A message asking for confirmation to start programming the firmware will appear. Click **YES**.
- 17 The updating process will begin. The device will then restart. After a few minutes, a message indicating the firmware update was successful will appear.
- 18 Click **OK**.
 - ➔ If the credential reader was changed, a factory default reset is recommended. See the user manual that came with the device for more information. WARNING: A factory default reset will delete all door information from the lock.

Legacy Device Firmware Update

Windows XP

Prerequisites

- ActiveSync should be installed on your PC.
 - See [Synchronization Software](#) on page 9 for more information.
- HHD should have a partnership with ActiveSync.

- Browse to www.schlage.com/support. Select the legacy product and click **View** under the **Firmware & Software** column. Download the latest firmware to your computer.



- Turn on the HHD and connect it to the computer. The Microsoft ActiveSync window will automatically appear.

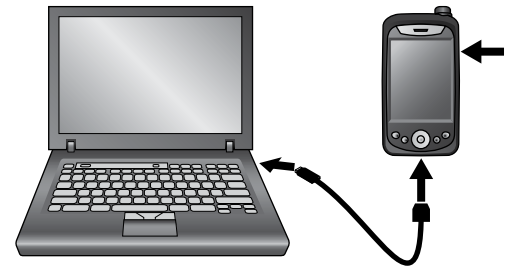

- In the Microsoft ActiveSync window click on the **Explore** button to open the HHD **My Documents** folder.

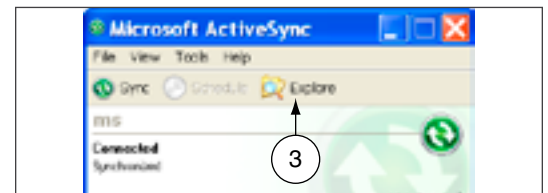

- Double click on **My windows Mobile-Based Device** link to go to the root directory of the HHD.

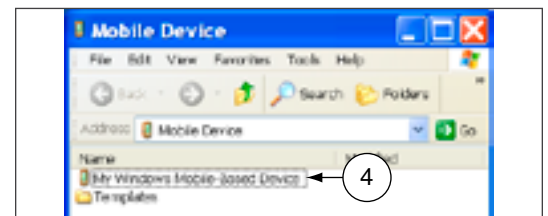

- 5 Copy the “.s19” firmware file available inside the .zip file (see step 1) and paste it inside the **My Windows Mobile-Based Device** folder.
- 6 Wait for HDD to synchronize.
- 7 Disconnect the HDD from computer.

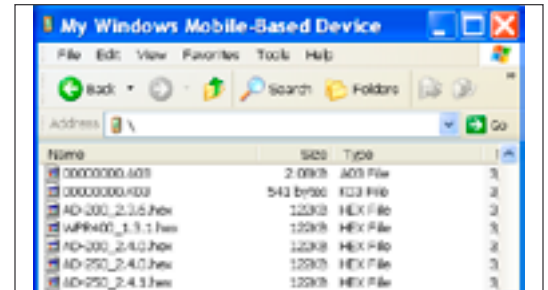

- 8 Go to the device and connect the HDD.
 - ➔ See **Connecting the Handheld Device** on page 20 for more information.
- 9 Start the Schlage Utility software.
 - ➔ See **Start the Schlage Utility Software** on page 15 for more information.
- 10 Login as a Manager.
 - ➔ See **Log in as a Manager** on page 16 for more information.
- 11 Click **Device Options** at the bottom of the screen.
- 12 Click **Firmware Update**.
- 13 Select the firmware file you would like to use and click **OK**.
- 14 Present a valid programming credential to the device and click **OK**.
- 15 The updating process will begin. The device will then restart. After a few seconds, a message indicating the firmware update was successful will appear.
- 16 Click **OK**.
- 17 Reset the device to factory defaults before any additional programming. See the user manual that came with the device for more information.

Windows 10, Windows 8, Windows 7 and Windows Vista

Prerequisites

- Microsoft Windows Mobile Device Center should be installed on your PC.
 - ➔ See [Synchronization Software](#) on page 9 for more information.
- HHD should have a partnership with Windows Mobile Device Center.

1 Browse to www.schlage.com/support. Select the legacy product and click **View** under the **Firmware & Software** column. Download the latest firmware to your computer.



2 Turn on the HHD and connect it to the computer. The Microsoft Windows Mobile Device Center window will automatically appear.

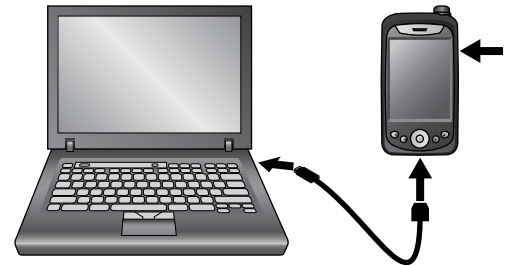

3 In the Microsoft Windows Mobile Device Center window click on **File Management** and then **Browse the contents of your device**.

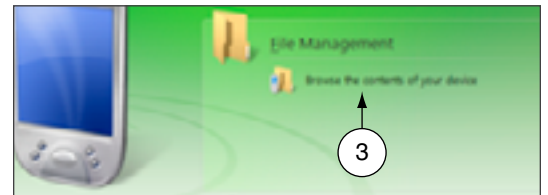

4 Double click on **** link to go to the root directory of the HHD.

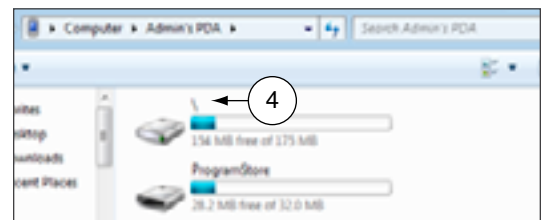

5 Copy the “.s19” firmware file available inside the .zip file (see step 1) and paste it inside the root folder (\).

6 Wait for HHD to synchronize.

7 Disconnect the HHD from computer.

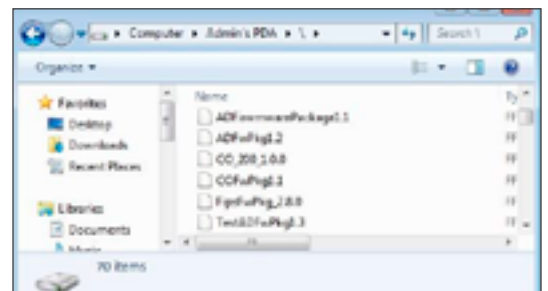

- 8 Go to the device and connect the HHD.
 - See [Connecting the Handheld Device](#) on page 20 for more information.
- 9 Start the Schlage Utility software.
 - See [Start the Schlage Utility Software](#) on page 15 for more information.
- 10 Login as a Manager.
 - See [Log in as a Manager](#) on page 16 for more information.
- 11 Click [Device Options](#) at the bottom of the screen.
- 12 Click [Firmware Update](#).
- 13 Select the firmware file you would like to use and click **OK**.
- 14 Present a valid programming credential to the device and click **OK**.
- 15 The updating process will begin. The device will then restart. After a few seconds, a message indicating the firmware update was successful will appear.
- 16 Click **OK**.
- 17 Reset the device to factory defaults before any additional programming. See the user manual that came with the device for more information.

Appendix C: Change Lock Class

AD-Series Locks

Windows XP

Prerequisites

- ActiveSync should be installed on your PC.
→ See **Synchronization Software** on page 9 for more information.
- HHD should have a partnership with ActiveSync.
- HHD should be already coupled with AD-Series device to be updated.
→ See **“Couple HHD to Lock”** for more information.

- 1 Browse to www.schlage.com/support.
- 2 Click **View** under the **Firmware & Software** column.
- 3 Click **AD Firmware Package - Tools & Docs** and save the “AD Firmware Pkg.zip” file to your computer.

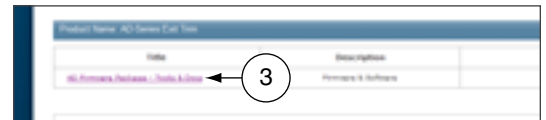
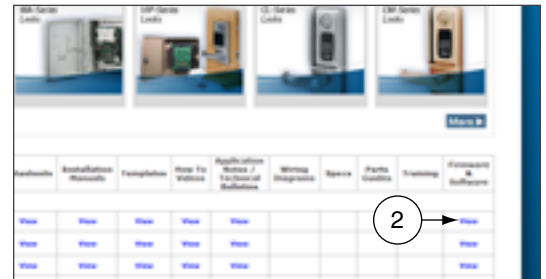

- 4 Turn on the HHD and connect it to the computer. The Microsoft ActiveSync window will automatically appear.

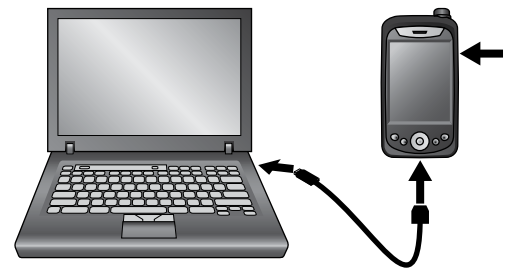

- 5 In the Microsoft ActiveSync window, click on the **Explore** button to open the HHD **Mobile Device** folder.

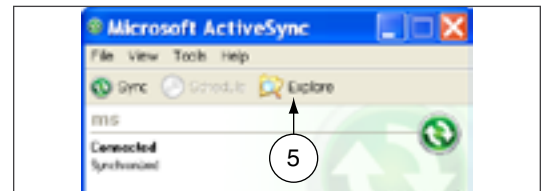

- 6 Double click on **My windows Mobile-Based Device** to go to the root directory of the HDD.

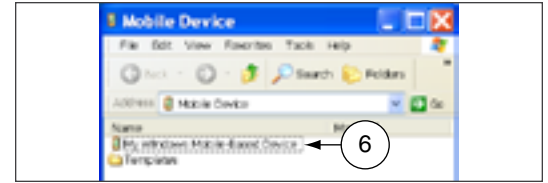

- 7 Copy the “.ffp” firmware file available inside the “AD firmware Pkg.zip” file (see step 3) and paste it inside the root folder <**My Windows Mobile-Based Device**>.

- 8 Wait for the HDD to synchronize.
9 Disconnect the HDD from computer.

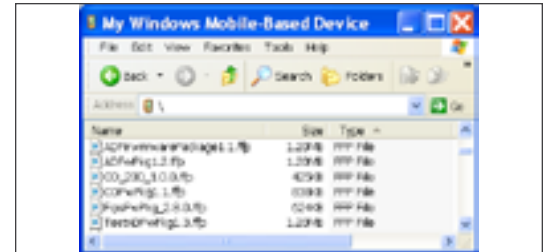

- 10 Go to the lock and connect the HDD.
→ See **Connecting the Handheld Device** on page 20 for more information.
- 11 Start the Schlage Utility software.
→ See **Start the Schlage Utility Software** on page 15 for more information.
- 12 Login as a Manager.
→ See **Log in as a Manager** on page 16 for more information.
- 13 Click **Device Options** at the bottom of the screen.
- 14 Click **Change Lock Class**.
- 15 Select the firmware package you would like to use and click **Next**.
- 16 All available lock classes are displayed on the screen. Select the appropriate lock class and then click **OK**.
→ Only locks with a magnetic reader can be changed to AD-250.
- 17 A message asking for confirmation to change the lock class will appear. Click **Yes**.
- 18 The change process will begin. Wait for the lock to restart. Once the confirmation message appears, the process is complete. Click **OK**.

Windows 10, Windows 8, Windows 7 and Windows Vista

Prerequisites

- Microsoft Windows Mobile Device Center should be installed on your PC.
 - ➔ See [Synchronization Software](#) on page 9 for more information.
- HHD should have a partnership with Windows Mobile Device Center.
- HHD should be already coupled with AD-Series device to be updated.
 - ➔ See [“Couple HHD to Lock”](#) or [“Couple HHD to PIM400 or PIB300”](#) for more information.

- 1 Browse to www.schlage.com/support.
- 2 Click **View** under the **Firmware & Software** column.
- 3 Click **AD Firmware Package - Tools & Docs** and save the “AD Firmware Pkg.zip” file to your computer.

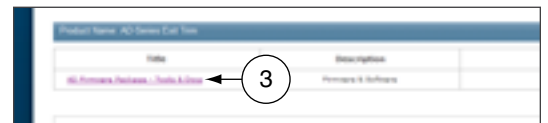

- 4 Turn on the HHD and connect it to the computer. The Microsoft Windows Mobile Device Center window will automatically appear.

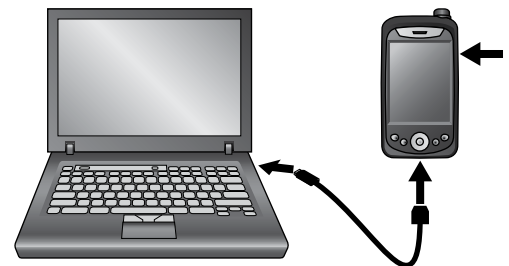

- 5 In the Microsoft Windows Mobile Device Center window, click on **File Management** and then **Browse the contents of your device** to open the HHD device contents.



- 6 Double click on **** to go to the root directory of the HHD.

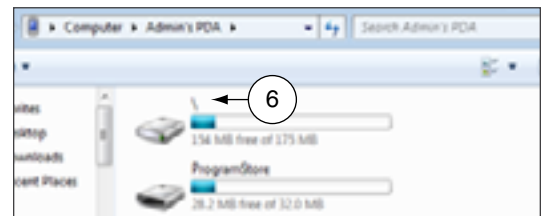

- 7 Copy the “.ffp” firmware file available inside the “AD firmware Pkg.zip” file (see step 3) and paste it inside the root folder (\).
- 8 Wait for the HDD to synchronize.
- 9 Disconnect the HDD from computer.

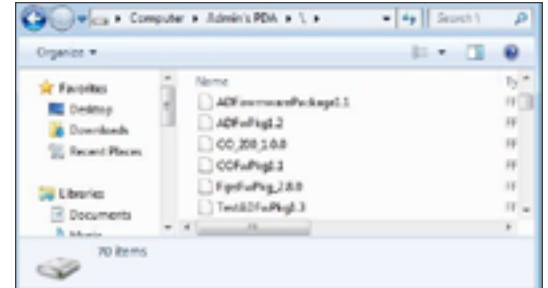

- 10 Go to the lock and connect the HDD.
 - ➔ See [Connecting the Handheld Device](#) on page 20 for more information.
- 11 Start the Schlage Utility software.
 - ➔ See [Start the Schlage Utility Software](#) on page 15 for more information.
- 12 Login as a Manager.
 - ➔ See [Log in as a Manager](#) on page 16 for more information.
- 13 Click **Device Options** at the bottom of the screen.
- 14 Click **Change Lock Class**.
- 15 Select the firmware package you would like to use and click **Next**.
- 16 All available lock classes are displayed on the screen. Select the appropriate lock class and then click **OK**.
 - ➔ Only locks with a magnetic reader can be changed to AD-250.
- 17 A message asking for confirmation to change the lock class will appear. Click **Yes**.
- 18 The change process will begin. Wait for the lock to restart. Once the confirmation message appears, the process is complete. Click **OK**.
- 19 Perform a Factory Default Reset of the lock before further use or programming.
 - ➔ See the user manual that came with the device for more information.

Appendix D: Device Template

About Device Template Feature

The Schlage Utility Software (SUS) version 4.10.2 (or higher) includes the Device Template feature.

Users may quickly change and copy “Device Properties” settings across multiple devices so that a group of devices may have the exact same settings applied.

A Device Template file may be initiated from and copied to locks and devices, saved on the HHD, transferred to another HHD, and saved to a computer or network drive.

Supported Locks and Controllers

AD-200	AD-402	PIM400-TD2
AD-250	WRI400	PIM400-485
AD-300	WPR400	CO-200
AD-302	CT5000	CO-220
AD-400	PIB300	CO-250

Prerequisites

- The HHD used must be coupled before the Device Template file may be saved or retrieved. See [Couple HHD to Lock](#) on page 24 for more information.
- The “source” lock or device must be installed and working as desired with all property settings configured as required by the user.
- The Device Template file can be saved and restored for a **specific hardware class only**. For example:
 - A Device Template created from an AD-200 Mag Swipe lock will not be available when the SUS is communicating with an AD-200 Prox lock.
 - A Device Template created from an AD-200 Prox lock will not be available with an AD-300 Prox lock.

Saving a Device Template will also capture the following device status parameters:

- Lock Firmware Version
- Reader Firmware Version
- Lock Serial number
- Reader Serial number
- Boot Loader Version
- Days Since Installed
- AA Battery Pack Type
- AA Battery Voltage
- Coin Cell Voltage

This information is saved within the Device Template file, and can be viewed with any text viewer by the user.

When naming the Device Template, use normal Windows OS naming conventions.

Create a Device Template

- 1 Connect the HHD to the device with desired properties.
 - ➔ If the device properties have not been programmed, configure the device properties as desired. Refer to AD-Series [Lock Properties](#) on page 31, or CO-Series [Lock Properties](#) on page 60.
- 2 Select **Device Options**.
- 3 Select **Lock Properties** for the connected device.
- 4 Select the **Edit** or **Reader** tab.
- 5 Select **Device Template** at the bottom of the screen.
- 6 Select **Save From Device** to create a Device Template file from the properties of this device.
- 7 Enter a name for the Device Template file.
 - ➔ The name should describe the device configuration this Template is intended to work with and clearly identify the hardware configuration. (Example: AD200-PRK main entrances.)
- 8 Tap **OK** to save. The SUS will display the location of the saved Template file.

Before copying, a Device Template file must be saved to the SUS, /My Documents/ and must be a hardware configuration match with the receiving device.

The device template file (.dtf) can be shared among devices by copying it from the my documents folder of one of the handhelds, saving it to a computer, and then copying it to the my documents folder of any handhelds that need the template.

Copy a Saved Device Template

- 1 Connect the HHD to the device that will receive the saved properties settings.
 - ➔ Be sure that the receiving device is of the same hardware configuration as that of the source of the Device Template. ([See Prerequisites on page 89 for more information.](#))
 - 2 Select **Device Options**.
 - 3 Select **Lock Properties** for the connected device.
 - 4 Select the **Edit** or **Reader** tab.
 - 5 Select **Device Template** at the bottom of the screen.
 - 6 Select **Save To Device** to copy and save a Device Template file to the connected device.
 - 7 Select the Device Template file name.
 - ➔ If the Device Template name is not available, check to be sure that the receiving device is of the same hardware configuration as that of the source of the Device Template. ([See Prerequisites on page 89 for more information.](#))
 - 8 Tap **OK** to save.
 - 9 Tap **YES** on the confirmation window, then tap **OK** again to finish.
- ➔ Saving a Device Template file to a PIM or PIB will require re-linking of all previously linked devices

Appendix E: Diagnostic Data Log

About Diagnostic Data Log Feature

The Schlage Utility Software (SUS) version 6.2.1 (or higher) includes the Diagnostic Data Log feature. This new feature provides a simple method for AD-Series customers to quickly gather and save important lockset information in a file. This Diagnostic Data file can then be shared with Technical Services for setup and configuration review and for analysis of issues from the field.

Supported Locks

AD-Series locksets (ONLY) - AD-200, AD-250, AD-300, AD-302, AD-400, AD-402

Prerequisites

- The HHD used must be coupled before the Diagnostic Data Log file may be saved. See [Couple HHD to Lock](#) on page 24 for more information.

Diagnostic Data Log Menu

Schlage Utility Software (SUS) version 6.2.1 (or higher) provides a new **Device Options** menu. This new **Diagnostic Data Log** menu will be available when the SUS is connected and communicating with AD-Series locksets. See **Diagnostic Data Log Menu**.



Diagnostic Data Log Menu

When the Diagnostic Data log menu is selected, the customer must then provide a name for the file and then select “OK” to continue. See **Enter a descriptive name**.

- NOTE: Be sure to provide a sufficiently descriptive name for the file so that you and others will know which AD-Series device and location the file pertains to.



Enter a descriptive name

Next, the SUS will request all data from the AD-Series device and save the file. See [Retrieving device data](#) screen shot.



Retrieving device data

Once the file is generated, the customer should copy and forward the Diagnostic Data file to Technical Services for detailed analysis. See [File ready for analysis](#) screen shot.

- ➔ NOTE: CO-Series products and non-lock AD-Series products do not support the Diagnostic Data Log feature

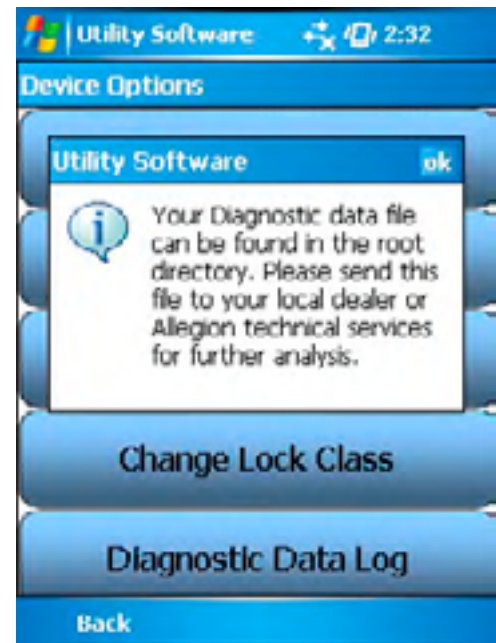

File ready for analysis

Index

A

AD-200 5, 6, 24, 31, 89
 AD-201 5, 24
 AD-250 5, 6, 24, 31, 89
 AD-300 5, 6, 24, 34, 89
 AD-301 24
 AD-302 5, 6, 24, 31, 34, 35, 49, 89, 91
 AD-400 5, 24, 38, 89
 AD-401 24
 AD-402 5, 24, 31, 38, 39, 40, 49, 89, 91
 AD-Series Controllers 24
 Edit Properties 27, 59
 Functions 6
 PIM400 Link Mode 28
 Program 26, 57
 Properties 42
 Supported 5, 24
 Update Firmware 77
 View Properties 27, 58
 AD-Series Locks 24
 Collect Audits 26
 Edit Properties 27, 59
 Edit Reader Properties 27, 59
 Functions 6
 Program 26, 57
 Properties 31, 60
 Supported 5, 24
 Update Firmware 77
 View Properties 27, 58
 View Reader Properties 27, 59
 AD-Series On-Line Devices 77

B

BE367 5, 6, 22, 62

C

Cache Mode 72
 Card Conversion 72
 CIP 8, 21, 22, 62, 63
 CL 5, 6, 8, 21, 62
 CL993 5
 CL5100 5
 CL5200 5
 CL5500 5
 CL5600 5
 CL Campus Lock 5, 62
 CM 6, 8, 21, 62, 72
 CM993 5
 CM5100 5
 CM5200 5
 CM5500 5
 CM5600 5
 CM5700 5
 CM Lock 72
 CO-200 5, 6, 57, 89
 CO-220 5, 6, 57, 89
 CO-250 5, 6, 57, 89
 Copy
 Device Template 90
 Create
 Device Template 90
 CT500 5, 6, 62
 CT1000 5, 62
 CT5000 5, 6, 24, 89
 Customer Service ii

D

DCS 72
 Delay 72
 Device Template 19, 89
 Copy 90
 Create 90
 Diagnostic Data Log 28, 91
 Door Prop Delay 72

E

Error Codes 67
 Extend Unlock 72

F

Fail Safe 72
 Fail Secure 72
 FC Mode 72
 FE210 22
 First 73

G

Glossary 72
 GUI 73

H

Handheld Device 5, 7, 8, 13, 20
 Connect 13, 20
 Couple to AD-Series Lock 24, 57
 Couple to PIM400 25
 Heartbeat 73
 HHD 5, 6, 7, 8, 11, 13, 15, 20, 21, 22, 23, 24,
 25, 26, 27, 28, 31, 34, 38, 43, 46, 47, 51,
 53, 57, 58, 59, 60, 62, 63, 64, 65, 75,
 76, 77, 78, 79, 80, 81, 82, 83, 84, 85, 86,
 87, 88, 90. **See also** Handheld Device
 HH-Serial 8, 21, 22, 23, 62
 HH-USB 8, 13, 24, 25, 57
 Hi Lo Output 73

I

Icons 14

K

KC2 5, 6, 62
 KC2-5100 5
 KC2-5500 5
 KC2-9000 5

L

Latch Type 73
 Legacy Controllers
 Diagnostics 65
 Edit Properties 64
 Functions 6
 Program 62
 Supported 5, 62
 Update Firmware 64, 81
 View Properties 63
 Legacy Locks
 Collect Audits 63
 Diagnostics 65
 Edit Properties 64
 Functions 6
 Program 62
 Properties 65
 Supported 5, 62
 Update Firmware 64, 81
 View Properties 63
 Log In
 Manager 16
 Operator 16

Index

M

Microsoft ActiveSync 10, 11, 78, 81, 85
Microsoft Windows Mobile Device
Center 11, 12
Mode 73

N

No Purge 72

O

Offline Lockdown Mode 32
ONR 77
Over Network Reprogramming 77

P

PIB300 iii, 5, 6, 24, 51, 89
PIM 5, 6, 8, 15, 23, 25, 28, 38, 39, 46, 47,
62, 65, 72, 73, 74
PIM400 iii, 5, 6, 24, 25, 28, 39, 40, 44,
47, 48, 49
PIM400-485 89
PIM400-TD2 89
PIMWA-CV 8, 23, 63
Programming Password 15, 18, 24, 25,
57, 76

R

Relatch Time 73
Relock delay 73
Request to Exit 74
Retry 74
RS485 PIM
Link a Door 65
Rxt 74
Rxt Sift 74

S

Schlage Utility Software
Connection Type 17
Door List 18
Install 13
Language 18
Options 17
Programming Password 18
Start 15
SUS Password 18
Update 13, 75, 89
Update Mode 18
SUS Password 15, 18
Synchronization Folder 11
Synchronization Software 7, 9, 10, 89
Configure 10
Download 9
Install 9
System Components 8

T

Troubleshooting 66

W

WA 8
WAPM 6, 74
Warranty iii
WPR 62
WPR2 62
WPR400 5, 24, 43, 89
WRI 62
WRI400 5, 24, 89
WSM 62

About Allegion

Allegion (NYSE: ALLE) creates peace of mind by pioneering safety and security. As a \$2 billion provider of security solutions for homes and businesses, Allegion employs more than 7,800 people and sells products in more than 120 countries across the world. Allegion comprises 23 global brands, including strategic brands CISA®, Interflex®, LCN®, Schlage® and Von Duprin®.

For more, visit www.allegion.com.

aptiQ ■ LCN ■ **SCHLAGE** ■ STEELCRAFT ■ VON DUPRIN