

















### PDQ Door Pulls Selection Guide

Pull Type	Model Number	Pull Description	Mounting Option (See Below)															
			Thru Bolt for Metal Or Wood				Thru Bolt for Glass		Back To Back				Rivnut Style					
			1	1HD	12	12HD	15	15HD	5	5HD	13	13HD	6	6HD	6R	6RHD	8	8HD
Round Straight Pulls	<a href="#">1B</a> 	5/8" Round Straight Pull 5-1/2" CTC	X		X		X											
	<a href="#">2C</a> 	3/4" Round Straight Pull 6" CTC	X		X		X						X		X		X	
	<a href="#">2D</a> 	3/4" Round Straight Pull 8" CTC	X		X		X						X		X		X	
	<a href="#">3D</a> 	1" Round Straight Pull 8" CTC		X		X		X						X		X		X
	<a href="#">H3D</a> 	1" Round Straight Pull 8" CTC ADA		X		X		X						X		X		X
	<a href="#">H3E</a> 	1" Round Straight Pull 10" CTC ADA		X		X		X						X		X		X
	<a href="#">H3F</a> 	1" Round Straight Pull 12" CTC ADA		X		X		X						X		X		X

Pull Type	Model Number	Pull Description	Mounting Option (See Below)																
			Thru Bolt for Metal Or Wood				Thru Bolt for Glass		Back To Back				Rivnut Style						
			1	1HD	12	12HD	15	15HD	5	5HD	13	13HD	6	6HD	6R	6RHD	8	8HD	
Round Straight Pull Plates	<a href="#">1B</a> 	Pull Plate with 5/8" Round Straight Pull having 5-1/2" CTC and 0.050" thick Plate	X		X														
	<a href="#">2C</a> 	Pull Plate with 3/4" Round Straight Pull having 6" CTC and 0.050" thick Plate	X		X								X		X		X		
	<a href="#">2D</a> 	Pull Plate with 3/4" Round Straight Pull having 8" CTC and 0.050" thick Plate	X		X								X		X		X		
	<a href="#">3D</a> 	Pull Plate with 1" Round Straight Pull having 8" CTC and 0.050" thick Plate		X		X								X		X		X	
	<a href="#">H3D</a> 	Pull Plate with 1" Round Straight Pull having 8" CTC ADA and 0.050" thick Plate		X		X								X		X		X	
	<a href="#">H3E</a> 	Pull Plate with 1" Round Straight Pull having 10" CTC ADA and 0.050" thick Plate		X		X								X		X		X	
	<a href="#">H3F</a> 	Pull Plate with 1" Round Straight Pull having 12" CTC ADA and 0.050" thick Plate		X		X								X		X		X	



Pull Type	Model Number	Pull Description	Mounting Option (See Below)															
			Thru Bolt for Metal Or Wood				Thru Bolt for Glass		Back To Back				Rivnut Style					
			1	1HD	12	12HD	15	15HD	5	5HD	13	13HD	6	6HD	6R	6RHD	8	8HD
Offset Pulls	<a href="#">9E</a> 	1" Round Offset Pull Handle 10" CTC		X		X		X						X		X		X
Back To Back Pulls	<a href="#">22C</a> 	3/4" Round Straight BTB Pull 6" CTC							X		X							
	<a href="#">22D</a> 	3/4" Round Straight BTB Pull 8" CTC							X		X							
	<a href="#">H33D</a> 	1" Round Straight BTB Pull 8" CTC ADA								X		X						
	<a href="#">H33E</a> 	1" Round Straight BTB Pull 10" CTC ADA								X		X						
	<a href="#">H33F</a> 	1" Round Straight BTB Pull 12" CTC ADA								X		X						
	<a href="#">99E</a> 	1" Round Offset Pull Handle BTB 10" CTC								X		X						

**Push Bars**

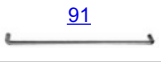
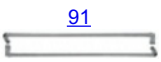
Pull Type	Model Number	Pull Description	Mounting Option (See Below)																
			Thru Bolt for Metal Or Wood				Thru Bolt for Glass		Back To Back				Rivnut Style						
			1	1HD	12	12HD	15	15HD	5	5HD	13	13HD	6	6HD	6R	6RHD	8	8HD	
Push Bars	 <a href="#">91</a>	33" CTC	X		X		X							X		X		X	
	 <a href="#">91</a>	33" CTC - Back To Back (BTB)							X		X;								

**Push Bar - Pull Set**

Pull Type	Model Number	Pull Description	Mounting Option (See Below)								
			Type	Common End		Free End					
				Back To Back		Thru Bolt for Metal Or Wood		Thru Bolt for Glass	Rivnut Style		
				5HD	13HD	1HD	12HD	15HD	6HD	8HD	
Push Bar - Pull	 <a href="#">91</a>	Push - Pull Bar Set	S	X		X					
			D	X			X				
			M	X						X	
			W	X					X		
			G		X						

## Mounting Options

### THRU BOLT

#### TYPE 1

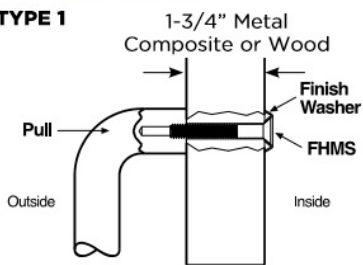

TYPE	BOLT SIZE	DRILL SIZE
1 (DEFAULT)	1/4 - 20	9/32"
1HD	5/16 - 18	11/32"

#### TYPE 12

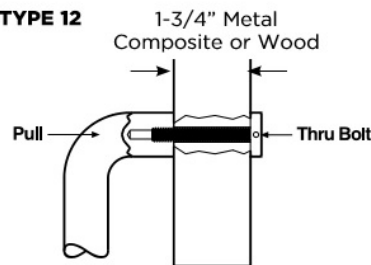

TYPE	BOLT SIZE	DRILL SIZE
12	1/4 - 20	9/32"
12HD	5/16 - 18	11/32"

#### TYPE 15

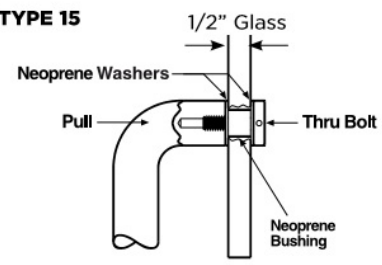

TYPE	BOLT SIZE	DRILL SIZE GLASS
15	1/4 - 20	5/8"
15HD	5/16 - 18	5/8"

### SURFACE CONCEALED

#### METAL DOOR - TYPE 6

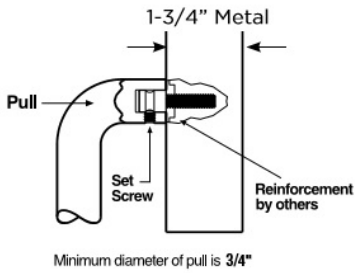

TYPE	BOLT SIZE	THREAD SIZE
6	1/4 - 20	1/4 - 20 TAP
6HD	5/16 - 18	5/16 - 18 TAP

#### METAL DOOR - TYPE 6R

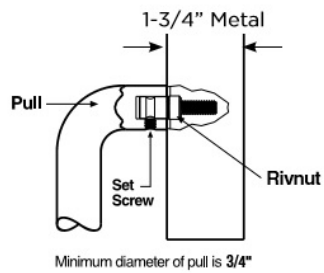

TYPE	BOLT SIZE	DRILL SIZE METAL
6R	1/4 - 20	3/8" X 1-1/4" DP
6RHD	5/16 - 18	1/2" X 1-1/4" DP

#### WOOD DOOR - TYPE 8

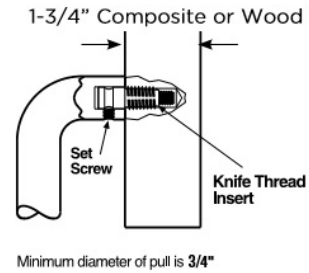

TYPE	BOLT SIZE	DRILL SIZE WOOD
8	1/4 - 20	1-1/4" DP
8HD	5/16 - 18	1-1/4" DP

# BACK TO BACK

## WOOD OR METAL DOOR - TYPE 5

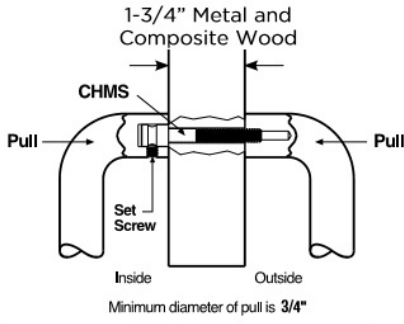

TYPE	BOLT SIZE	DRILL SIZE
5 (DEFAULT)	1/4 - 20	9/32"
5HD	5/16 - 18	11/32"

## GLASS TYPE 13

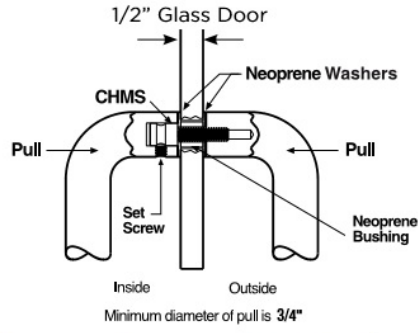

TYPE	BOLT SIZE	DRILL SIZE GLASS
13 (DEFAULT)	1/4 - 20	5/8"
13HD	5/16 - 18	5/8"