



NARROW STILE LEVER TRIM DESIGNS

Assorted outside trims provide security for all types of installations. Built to be as durable as the panic devices, these heavy-duty trims will stand up to heavy use and abuse. The versatile design of the trims, combined with the device mounting plate, makes changing functions as simple as replacing the outside trim. This can easily be done without removing the exit device from the door. Narrow stile trims can be used on 40 Series Rim, 50 / 51 Series Surface Vertical Rods and 60 / 61 / 62 / 63 Concealed Vertical Rods. Detex uses the BHMA functions/descriptions for all trims. Anti-Microbial Coating (AM) is available on all levers - contact factory for lead time and details.

DN / DNV / EU2W Trim

S Lever Standard



S Lever

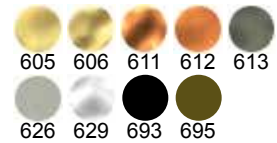
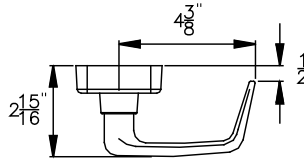

T Lever

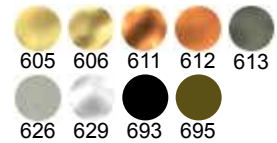
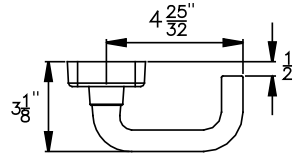
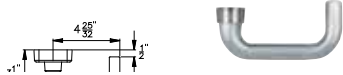

U Lever

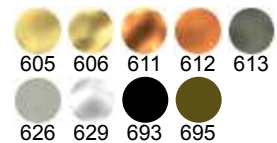
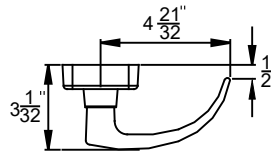

Q Lever

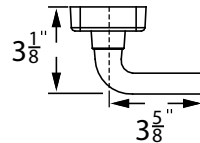

- 605 / US3 Polished Brass
- 606 / US4 Brushed Brass
- 611 / US9 Polished Bronze
- 612 / US10 Brushed Bronze
- 613 / US10B Oil Rubbed Bronze
- 626 / US26D Brushed Chrome
- 629 / US32 Polished Stainless Steel
- 693 / SPBLK Black Painted
- 695 / SP313 Dark Bronze Painted

FSB Contemporary/European Designed Levers (630/US32D Brushed Stainless Steel Finish)

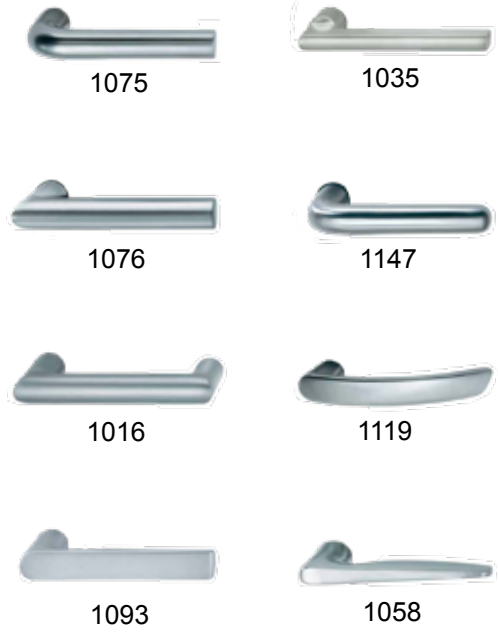
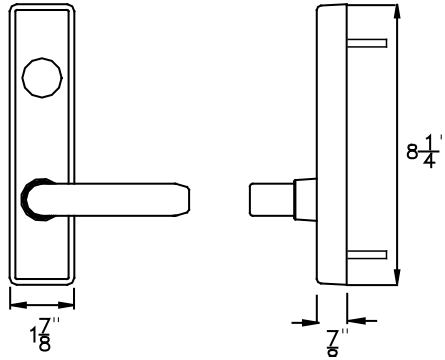

FSB Lever Trims available in only 630/US32D Brushed Stainless Steel

BHMA Function/Description

- 01 - Exit only, no trim or blank escutcheon
- 02 - Entrance by trim when actuating bar is dogged (dummy)
- 08 - Entrance by lever. Key locks or unlocks lever. (classroom)
- 09 - Entrance by knob or lever only when released by key. Key removable only when locked. (storeroom)
- 14 - Entrance by trim when latch bolt is released by lever. Always active, no cylinder. (passage)
- EU2W - Electric Lock / Unlock, wide escutcheon - Fail Secure or Fail Safe - Specify handing (Not field reversible)

LS Lever Switch

- Monitors the lever and sends a signal to access control when lever is rotated
- Available on 08DN, 09DN, 14DN and EU2W levers only
- Not retrofittable or field reversible - must specify handing

Technical Information

- DN Trims are Forged Brass
- KN - Knurling available on all levers
- Advantex narrow stile trim also available for use with all Value Series Devices
- Door Thickness - Fits standard 1-3/4" - 2-1/4" doors (for other door thicknesses contact factory)
- When ordered with device, trims will match mounting plate specified
- Narrow stile trim configured for use with BP2 - Standard for use on 40, 50/51 Series, BP10 - Standard for use on 60/61, 62/63 Series
- A short cylinder collar is supplied for mortise cylinders 1" to 1-1/8" long. For cylinders greater than 1-1/8", order tall cylinder collar part #100752-X

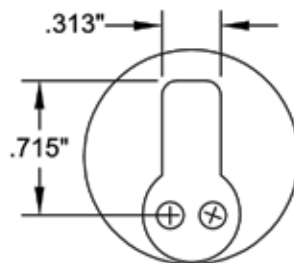

Mortise Cylinder with standard Yale cam required



Detex Corporation
 302 Detex Drive
 New Braunfels, Texas 78130-3045 USA
 PH. (830) 629-2900
 (800) 729-3839
 FAX (800) 653-3839
 http://www.detex.com
 USA Sales:
 marketing@detex.com
 International Sales:
 export@detex.com

Cancer & Reproductive Harm - www.detex.com/prop65