



# Price List #10

Effective February 6, 2017

Supersedes all previous price lists

---

## **Table of Contents**

- TARGET 1 Quick Ship..... 3
- Overhead Holders & Stops ..... 4-6
- Hospital Push/Pull Latches ..... 7-10
- Electromagnetic Door Holders ..... 11
- Electrical Power Transfers ..... 12
- Coordinators ..... 13
- Roller Latches ..... 13
- Flush Bolts ..... 14
- Aluminum Geared Hinges ..... 15-19
- Stainless Steel Pin & Barrel Hinges .... 20-23
- Stainless Steel Door Edge Guards ..... 24
- Pivots & Pivot Sets ..... 25-28
- Rescue Hardware ..... 29-30
- Miscellaneous ..... 31



**1. Contact Us**

- orders@abhmfg.com – Send all Purchase Orders or questions regarding existing orders.
- quotes@abhmfg.com – Send all Quote Requests or questions regarding existing quotes.
- ar@abhmfg.com – Send all questions regarding invoices, statements, credit issues or RMA requests.

**2. Prices**

- List prices are effective on the date appearing on the cover and are subject to change without notice.
- Prices shown herein are subject to discounts in effect at the time orders are acknowledged in writing.
- Errors or omissions are subject to correction.
- All quoted jobs must clearly reference quote number on purchase order in order to receive special quoted prices.

**3. Freight**

- All orders are shipped F.O.B. factory.
- Prepaid freight allowed on net orders of \$1,000 or more within 48 contiguous states by carrier of our choice.
- Orders shipping to Alaska or Hawaii require \$2,500 net to qualify for prepaid freight.

**4. Terms**

- All invoices are due Net 30. Discounts may be allowed, if previously arranged with ABH. **No discount allowed on freight.**
- 1-1/2% may be charged on all accounts 30 days past due (18% annually).

**5. Order Entry**

- Any order received by 12 noon CST will be entered the same day, provided all required details are included when order is received.
- You will receive an order acknowledgment via email or fax the following morning with expected ship date for your review.

**6. Minimum Orders**

- No minimum order requirements.

**7. Order Cancellations & Revision Requests**

- Standard lead time orders that are cancelled or revised after **3 days** of order entry will incur a restock fee determined by ABH.
- Expedited, made-to-order or special orders cannot be cancelled or revised after production has begun.

**8. Returns**

- All RMA requests must be submitted to ABH in writing within **6 months** from date of invoice.
- All return shipments must be accompanied by a copy of the ABH-issued RMA to serve as a packing list.
- Freight costs to return goods must be prepaid by customer, unless previously authorized by ABH.
- Any freight prepaid by ABH on the original order will be subtracted from the total amount to be credited to customer.
- All goods must be returned to ABH within **60 days** from RMA authorization date in the same condition the original order left the ABH factory. Any RMA received after the 60 days is subject to reevaluation of replacement and/or restocking charge.
- Credit for RMA will be applied to customer's account. No cash or checks will be issued.
- For all RMAs where a replacement is requested, ABH will invoice the replacement in full and the customer will be held responsible for the invoice. Once the RMA product is received and inspected by ABH, the appropriate credit will be issued.

**9. Claims**

- All claims as to defects, errors or shortages shall be reported in writing within **10 days** from receipt of order.

**10. Product Changes**

- ABH reserves the right to make changes or improvements in design, material, parts or specifications; as well as to discontinue products at any time.

**11. Limited Warranty**

- ABH warrants its products sold in the United States of America are free from defects in material or workmanship under normal use and service for a minimum period of one year from date of shipment.
- See website for specific product warranty details.
- Repair or replacement of defective products during this period shall be the only remedy under this warranty.
- Does not cover defects or damage as a result of improper use or maintenance, vandalism, abuse, accident, ordinary wear and tear or shipping and handling.

ABH Standard Finishes*					
Description	BHMA/ANSI Code	Nearest U.S. Equivalent	Description	BHMA/ANSI Code	Nearest U.S. Equivalent
Zinc Plated	603	US2G	Satin Stainless Steel	630	US32D
Bright Brass	605	US3	Painted Primed	600	USP
Satin Brass	606	US4	Painted Aluminum	689	S1
Satin Bronze	612	US10	Painted Brass (to match US4)	696	S2
Dark Bronze	613	US10B	Painted Bronze (to match US10)	691	S3
Bright Chrome Plated	625	US26	Painted Black	693	S4
Satin Chrome Plated	626	US26D	Painted Dark Bronze (to match US10B)	690	S5
Satin Aluminum	628	US28	Painted White	-	S8
Bright Stainless Steel	629	US32	<b>*Contact factory for any custom finish or application</b>		



# Need it ASAP? No problem!

All products listed below will ship within 3 business days from date of order entry at **Standard Buying Program!**  
(Based on availability - contact factory for details)

- All orders must be clearly marked **Target 1** or the order will default to the standard lead time.
- If an order is placed with additional products not offered on **Target 1**, the entire order will revert to standard lead time.
- ABH® also offers **Target 3** program (limited discount) for other products based upon availability - Contact factory.

<b>Overhead Stops &amp; Holders</b>	<ul style="list-style-type: none"> <li>• <b>1000-US32D</b> – Concealed Mount, Heavy Duty</li> <li>• <b>9000-US32D</b> – Surface Mount, Heavy Duty</li> <li>• <b>7000-US32D</b> – Surface Mount, Heavy Duty</li> </ul>	<ul style="list-style-type: none"> <li>• <b>4000-US32D</b> – Concealed Mount, Medium Duty</li> <li>• <b>4400-US32D</b> – Surface Mount, Medium Duty</li> <li>• <b>44443-US32D</b> or <b>90541-US32D</b> - Angle Jamb Brackets</li> </ul>
<b>Hospital Push/Pull Latches</b>	<ul style="list-style-type: none"> <li>• <b>6000-US32D</b> – 2-3/4” or 5” Cylindrical Latch</li> <li>• <b>6800-US32D</b> – Low Profile, 2-3/4” or 5” Cylindrical Latch</li> <li>• <b>6800Q-US32D</b> – Low Profile, 2-3/4” or 5” Cylindrical Latch - Quiet Glide</li> </ul>	<ul style="list-style-type: none"> <li>• <b>605912-US32D</b> - 1-1/2” Extended Lip ASA Strike</li> <li>• <b>605958-US32D</b> - 1-5/8” Extended Lip ASA Strike</li> </ul>
<b>Electro-magnetic Holders</b>	<ul style="list-style-type: none"> <li>• <b>2100-US28</b> - Recessed Mount, Tri-Voltage</li> <li>• <b>2300-US28</b> - Surface Mount, Tri-Voltage</li> <li>• <b>20038, 20050, 20075, 20100, 20200, 20400, 20600 &amp; 20020-US28</b> - Standard Door Armature &amp; Extensions</li> </ul>	<ul style="list-style-type: none"> <li>• <b>2400-US28</b> - Flush Mount, Tri-Voltage</li> <li>• <b>2600-US28</b> - Single Floor Mount, Tri-Voltage</li> </ul>
<b>Aluminum Continuous Geared Hinges</b>	<p>All Standard Finishes, Heights &amp; Options </p>	
<b>Stainless Steel Pin &amp; Barrel Continuous Hinges</b>	<ul style="list-style-type: none"> <li>• <b>A500083-US32D</b> - Full Concealed, 83-1/8”</li> <li>• <b>A505083-US32D</b> - Full Concealed w/ Dual EdgeGuards, 83-1/8”</li> <li>• <b>A502083-US32D</b> - Full Surface, 83-1/8”</li> <li>• <b>A515083-US32D</b> - Full Concealed w/ Single Edge Guard, 83-1/8”</li> <li>• <b>A511083-US32D</b> - Full Concealed, Swing Clear w/ Edge Guard, 83-1/8”</li> </ul>	
<b>Pivots &amp; Pivot Sets</b>	<ul style="list-style-type: none"> <li>• <b>0117-US32D</b> – Pivot Set , 3/4” Offset, Floor Mount, Medium Duty (0180 Top Pivot included)</li> <li>• <b>0127-US32D</b> – Pivot Set, Center Hung, Side Jamb Mount (0320 Top Pivot included)</li> <li>• <b>0128-US32D</b> – Pivot Set, Center Hung, Floor Mount (0320 Top Pivot included)</li> <li>• <b>0147-US32D</b> – Pivot Set , 3/4” Offset, Floor Mount, Heavy Duty (0180 Top Pivot included)</li> <li>• <b>0195-US32D</b> – Pivot Set, 3/4” Offset, Side Jamb Mount (0180 Top Pivot included)</li> <li>• <b>019-US32D</b> – Intermediate Pivot, 3/4” Offset</li> <li>• <b>0519-US32D</b> – Pocket Pivot</li> <li>• <b>0923-US2G</b> – Reinforcing Pivot</li> </ul>	
<b>Electrical Power Transfers</b>	<ul style="list-style-type: none"> <li>• <b>PT1000-US28</b> – (10) 24 AWG Wires</li> <li>• <b>PT105-US32D</b> – Allows for up to 105° Opening</li> </ul>	<ul style="list-style-type: none"> <li>• <b>PT200-US28</b> – (2) 18 AWG Wires</li> <li>• <b>PT180-US32D</b> – Allows for up to 180° Opening</li> </ul>
<b>Flush Bolts</b>	<ul style="list-style-type: none"> <li>• <b>1860P-US32D</b> – Automatic Flush Bolts for Metal Doors</li> <li>• <b>1862P-US32D</b> – Automatic Flush Bolts for Wood Doors</li> </ul>	
<b>Coordinators</b>	<ul style="list-style-type: none"> <li>• <b>3780-USP</b> – Universal Coordinator</li> <li>• <b>3721-US28</b> – For Equal Pairs of Doors 56-1/16” to 72”</li> </ul>	
<b>Surface Bolts</b>	<ul style="list-style-type: none"> <li>• <b>N1815TB-US32D</b> – 8” with Top &amp; Bottom Strike</li> <li>• <b>N1815BLT-US32D</b> – 8” w/ Top &amp; Bottom Strike &amp; Locking Bracket</li> </ul>	
<b>Slide Bolts</b>	<ul style="list-style-type: none"> <li>• <b>1884A-US32D</b> – Slide Bolt with Locking Feature, 2-3/4” Backset &amp; ASA Strike</li> </ul>	
<b>Roller Latches</b>	<ul style="list-style-type: none"> <li>• <b>1890-US32D</b> – Roller Latch with 1-11/16” Cast Strike</li> </ul>	



# OVERHEAD HOLDERS & STOPS – CONCEALED

1000 Series** • Concealed Mount • Heavy Duty	Model Number			Frame Opening Size (Nominal)		US32D	US10, US10B, US26D, US4	US26, US3, US32	S1, S2, S3, S4, S5, S8
	Hold Open	Stop	Friction	Butt Hinges or Offset Pivots	Center Hung				
	1016*	1026*	1036*	18" - 22-15/16"	-				
1017*	1027*	1037*	23" - 26-15/16"	-					
1011*	1021*	1031*	27" - 29-15/16"	30" - 32-15/16"					
1012	1022	1032	30" - 35-15/16"	33" - 38-15/16"					
1013	1023	1033	36" - 39-15/16"	39" - 42-15/16"					
1014	1024	1034	40" - 43-15/16"	43" - 46-15/16"					
1015	1025	1035	44" - 52"	47" - 54"					
N1000 Series - All Stainless Steel Components - \$70 List Add (Option "N")									

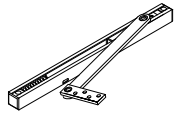

1000A Series • Concealed Mount • Heavy Duty • Adjustable	Model Number			Frame Opening Size (Nominal)		US32D	US10, US10B, US26D, US4	US26, US3, US32	S1, S2, S3, S4, S5, S8
	Hold Open	Stop	Friction	Butt Hinges or Offset Pivots	Center Hung				
	1011A*	1021A*	1031A*	27" - 29-15/16"					
1012A	1022A	1032A	30" - 35-15/16"						
1013A	1023A	1033A	36" - 39-15/16"						
1014A	1024A	1034A	40" - 43-15/16"						
1015A	1025A	1035A	44" - 52"						
N1000A Series - All Stainless Steel Components - \$70 List Add (Option "N")									

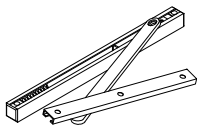

1000SL Series • Concealed Mount • Heavy Duty • Slim Line	Model Number			Frame Opening Size (Nominal)		US32D	US10, US10B, US26D, US4	US26, US3, US32	S1, S2, S3, S4, S5, S8
	Hold Open	Stop	Friction	Butt Hinges or Offset Pivots	Center Hung				
	1011SL*	1021SL*		27" - 29-15/16"	30" - 32-15/16"				
1012SL*	1022SL*		30" - 35-15/16"	33" - 38-15/16"					
1013SL	1023SL		36" - 39-15/16"	39" - 42-15/16"					
1014SL	1024SL		40" - 43-15/16"	43" - 46-15/16"					
1015SL	1025SL		44" - 52"	47" - 54"					
N1000SL Series - All Stainless Steel Components - \$70 List Add (Option "N")									

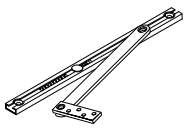

1000SA Series • Concealed Mount • Heavy Duty • Slim Line • Adjustable	Model Number			Frame Opening Size (Nominal)		US32D	US10, US10B, US26D, US4	US26, US3, US32	S1, S2, S3, S4, S5, S8
	Hold Open	Stop	Friction	Butt Hinges or Offset Pivots	Center Hung				
	1011SA*	1021SA*		27" - 29-15/16"					
1012SA	1022SA		30" - 35-15/16"						
1013SA	1023SA		36" - 39-15/16"						
1014SA	1024SA		40" - 43-15/16"						
1015SA	1025SA		44" - 52"						
N1000SA Series - All Stainless Steel Components - \$70 List Add (Option "N")									

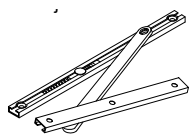

4000 Series** • Concealed Mount • Medium Duty	Model Number			Frame Opening Size (Nominal)		US32D	US10, US10B, US26D, US4	US26, US3, US32	S1, S2, S3, S4, S5, S8
	Hold Open	Stop	Friction	Butt Hinges or Offset Pivots	Center Hung				
	4011	4021	4031	18" - 23-15/16"	-				
4012	4022	4032	24" - 29-15/16"	-					
4013	4023	4033	30" - 35-15/16"	32" - 37-15/16"					
4014	4024	4034	36" - 48"	38" - 48"					
N4000 Series - All Stainless Steel Components - \$40 List Add (Option "N")									

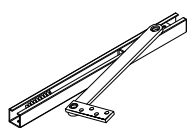

\*Check template for possible restrictions depending on degree of opening. Contact factory for special layout options.  
 \*\* Available on Target 1 – Quick Ship Program – See page 3 for details.



# OVERHEAD HOLDERS & STOPS – SURFACE MOUNT

<b>3300A Series</b> • Surface Mount • Medium Duty • Adjustable 	Model Number			Frame Opening Size (Nominal)		US32D	US10, US10B, US26D, US4	US26, US3, US32	S1, S2, S3, S4, S5, S8
	Hold Open	Stop	Friction	Butt Hinges or Offset Pivots					
	3311A	3321A	3331A	24" - 29-15/16"		\$129	\$155	\$173	\$155
	3312A	3322A	3332A	30" - 35-15/16"					
	3313A	3323A	3333A	36" - 42"					
N3300A Series - All Stainless Steel Components - \$40 List Add (Option "N")									

<b>3400 Series</b> • Surface Mount • Medium Duty 	Model Number			Frame Opening Size (Nominal)		US32D	US10, US10B, US26D, US4	US26, US3, US32	S1, S2, S3, S4, S5, S8
	Hold Open	Stop	Friction	Butt Hinges or Offset Pivots					
	3414	3424	3434	24" - 36"		\$129	\$155	\$173	\$155
N3400 Series - All Stainless Steel Components - \$40 List Add (Option "N")									

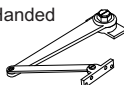
<b>3500 Series</b> • Surface Mount • Handed 	Model Number		Frame Opening Size (Nominal)		US32D	US10, US10B, US26D, US4	US26, US3, US32	S1, S2, S3, S4, S5, S8
	180° Parallel Arm Holder		Butt Hinges or Offset Pivots					
	3500L		24" - 36"		-	-	-	\$108
3500R		24" - 36"		-	-	-	\$108	

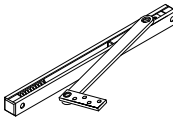
<b>4400 Series**</b> • Surface Mount • Medium Duty 	Model Number			Frame Opening Size (Nominal)		US32D	US10, US10B, US26D, US4	US26, US3, US32	S1, S2, S3, S4, S5, S8
	Hold Open	Stop	Friction	Butt Hinges or Offset Pivots	Center Hung				
	4411	4421	4431	18" - 23-15/16"	22" - 27-7/16"	\$102**	\$157	\$171	\$110
	4412	4422	4432	24" - 29-15/16"	27-1/2" - 33-7/16"				
	4413	4423	4433	30" - 35-15/16"	33-1/2" - 38-15/16"				
4414	4424	4434	36" - 48"	39" - 48"					
N4400 Series - All Stainless Steel Components - \$40 List Add (Option "N")									

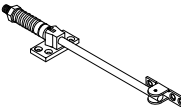
<b>7000 Series**</b> • Surface Mount • Heavy Duty  Bar always supplied cad plated (silver), except for "N" Series (stainless steel).	Model Number		Frame Opening Size (Nominal)		US32D	US10, US10B, US26D, US4	US26, US3, US32	S1, S2, S3, S4, S5, S8	
	Hold Open	Stop	Butt Hinges or Offset Pivots	Center Hung					
	7010	7020	23" - 28-15/16"	24" - 31-15/16"	\$209**	\$236	\$251	\$224	
	7011	7021	29" - 34-15/16"	32" - 38-7/16"					
	7012	7022	35" - 40-15/16"	38-1/2" - 44-3/16"					
	7013	7023	41" - 46-15/16"	44-1/4" - 50-3/16"					
7014	7024	47" - 54"	50-1/4" - 60"						
N7000 Series - All Stainless Steel Components - \$70 List Add (Option "N")									

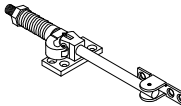
<b>HD7000 Series</b> • Surface Mount • Extra Heavy Duty  Bar always supplied cad plated (silver), except for "N" Series (stainless steel).	Model Number		Frame Opening Size (Nominal)		US32D	US10, US10B, US26D, US4	US26, US3, US32	S1, S2, S3, S4, S5, S8	
	Hold Open	Stop	Butt Hinges or Offset Pivots	Center Hung					
	HD7010	HD7020	24" - 29-15/16"	26" - 31-15/16"	\$550	\$600	\$630	\$410	
	HD7011	HD7021	30" - 35-15/16"	32" - 38-15/16"					
	HD7012	HD7022	36" - 39-15/16"	39" - 42-15/16"					
	HD7013	HD7023	40" - 47-15/16"	43" - 50-15/16"					
HD7014	HD7024	48" - 54"	51" - 60"						
NHD7000 Series - All Stainless Steel Components - \$100 List Add (Option "N")									

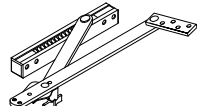
<b>8000 Series</b> • Surface Mount • Extra Heavy Duty 	Model Number		Frame Opening Size (Nominal)		US32D	US10, US10B, US26D, US4	US26, US3, US32	S1, S2, S3, S4, S5, S8
	Hold Open	Stop	Butt Hinges or Offset Pivots	Center Hung				
	8010	8020	27" - 32-7/16"	29-1/2" - 34-15/16"	\$206 Stop \$232 H.O.	\$325 Stop \$371 H.O.	\$341 Stop \$386 H.O.	\$213 Stop \$240 H.O.
	8011	8021	32-1/2" - 38-11/16"	35" - 41-7/16"				
	8012	8022	38-3/4" - 42-7/16"	41-1/2" - 44-15/16"				
8013	8023	42-1/2" - 54"	45" - 56"					

\*Check template for possible restrictions depending on degree of opening. Contact factory for special layout options.

\*\* Available on Target 1 – Quick Ship Program – See page 3 for details.

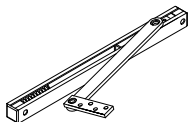

# OVERHEAD HOLDERS & STOPS – SURFACE, OPTIONS & PARTS

9000 Series** • Surface Mount • Heavy Duty	Model Number			Frame Opening Size (Nominal)		US32D	US10, US10B, US26D, US4	US26, US3, US32	S1, S2, S3, S4, S5, S8
	Hold Open	Stop	Friction	Butt Hinges or Offset Pivots	Center Hung				
	9018	9028	9038	24" - 27-15/16"	26" - 29-15/16"	\$224**	\$356	\$372	\$238
	9011	9021	9031	28" - 29-15/16"	30" - 33-15/16"				
	9012	9022	9032	30" - 31-15/16"	34" - 35-15/16"				
	9013	9023	9033	32" - 35-15/16"	36" - 38-15/16"				
	9014	9024	9034	36" - 39-15/16"	39" - 40-15/16"				
	9015	9025	9035	40" - 41-15/16"	41" - 44-15/16"				
	9016	9026	9036	42" - 43-15/16"	45" - 46-15/16"				
	9017	9027	9037	44" - 54"	47" - 56"				
<b>N9000 Series - All Stainless Steel Components - \$70 List Add (Option "N")</b>									

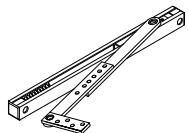
9000A Series • Surface Mount • Heavy Duty • Adjustable	Model Number			Frame Opening Size (Nominal)		US32D	US10, US10B, US26D, US4	US26, US3, US32	S1, S2, S3, S4, S5, S8
	Hold Open	Stop	Friction	Butt Hinges or Offset Pivots	Center Hung				
	9011A	9021A	9031A	28" - 31-15/16"		\$280	\$380	\$412	\$301
	9012A	9022A	9032A	32" - 39-15/16"					
	9013A	9023A	9033A	40" - 43-15/16"					
	9014A	9024A	9034A	44" - 54"					
<b>N9000A Series - All Stainless Steel Components - \$70 List Add (Option "N")</b>									

Options - Overhead Holders & Stops		List Add
44443	Angle Jamb Bracket for 3300A & 4400 Series (Specify Finish)	\$49
70377	Angle Jamb Bracket for 7000 Series (Specify Finish)	\$49
90541	Angle Jamb Bracket for 8000, HD8000, 9000 & 9000A Series (Specify Finish)	\$49
CL	For use with cam lift hinges (1/2" lift maximum)	\$100
HC	Hold-Closed	\$90
LL	Lead-lined	\$70 = Surface \$90 = Concealed
LS	Less Spring	\$30
NON-FERROUS SCREW	Non-ferrous fasteners provided in lieu of standard fasteners	\$25
SNB	Add Sex Bolt Fasteners to Surface Mount Std Screw Pack (3500 Series Only)	\$25
SEC	Security Fasteners (Specify Door & Frame Material)	\$25
T	Threaded pivot screw & nylon washer in lieu of standard jamb bracket	\$30
THICK	Special door thickness (see catalog for standard door thicknesses for each respective model)	\$25
<b>CUSTOM APPLICATIONS AVAILABLE - CONTACT FACTORY (ENGINEERING FEE WILL APPLY - MINIMUM \$50)</b>		

Parts - Overhead Holders & Stops		List Add
SCREW PACK	Standard Screw Pack (Specify Model & Finish)	\$20 = Surface \$30 = Concealed
SCREW PACK-SEC	Screw Pack with Security Fasteners (Specify Model & Finish)	\$35 = Surface \$45 = Concealed
4000F-KIT	Friction Conversion Kit for 4000, 4400 & 3300A Series	\$24 \$50 = "N" Series
9000F-KIT	Friction Conversion Kit for 1000, 1000A, 9000 & 9000A Series	
4000HO-KIT	Hold Open Conversion Kit for 4000, 4400 & 3300A Series	
9000HO-KIT	Hold Open Conversion Kit for 9000 & 9000A	
1000HO-KIT	Hold Open Conversion Kit for 1000 & 1000A	
R4401	Jamb Bracket Reinforcement for 4000 Series, Zinc Plated	\$26
R90541	Jamb Bracket Reinforcement for 1000 & 1000SL Series, Zinc Plated	
9000JF	Jamb Bracket Filler/Shim for 1000, 1000SL, 8000 & 9000 Series - 1/4" Thick (Specify Finish)	\$26
4000JF	Jamb Bracket Filler/Shim for 3300A, 4000 & 4400 Series - 3/16" Thick (Specify Finish)	

\*Check template for possible restrictions depending on degree of opening. Contact factory for special layout options.

\*\* Available on Target 1 – Quick Ship Program – See page 3 for details.

Innovation, Quality, Customer Service . . .  *Makes Life Simple* 2/6/17

Tel (630) 875-9900

Fax (800) 932-9224

www.abhmfg.com

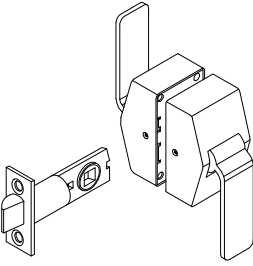
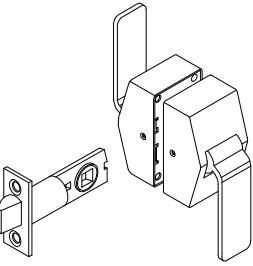
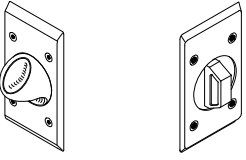
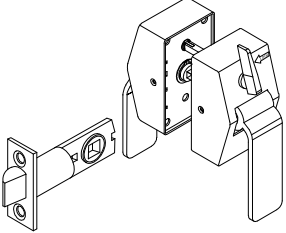
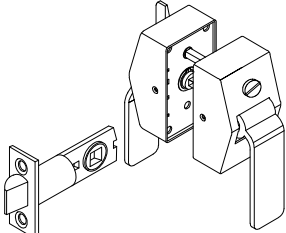

# PUSH/PULL LATCHES - CYLINDRICAL

<b>6000</b> 	<b>6000** Series - Cylindrical</b>	<b>US32D</b>	<b>US26D, US10, US10B, US4</b>	<b>US26, US3,US32</b>
	<b>602**</b> 2-3/4" Backset & T-Strike	<b>\$226**</b>	<b>\$316</b>	<b>\$361</b>
	<b>602A**</b> 2-3/4" Backset & ASA Strike			
	<b>603</b> 3-3/4" Backset & T-Strike			
	<b>603A</b> 3-3/4" Backset & ASA Strike			
	<b>605**</b> 5" Backset & T-Strike			
	<b>605A**</b> 5" Backset & ASA Strike			
	<b>607</b> 7" Backset & T-Strike	<b>\$263</b>	<b>\$353</b>	<b>\$398</b>
<b>607A</b> 7" Backset & ASA Strike				
<b>6100</b> 	<b>6100 Series - Cylindrical - 161 Prep Only - No Thru-Bolts Required</b>	<b>US32D</b>	<b>US26D, US10, US10B, US4</b>	<b>US26, US3,US32</b>
	<b>612</b> 2-3/4" Backset & T-Strike	<b>\$286</b>	<b>\$386</b>	<b>\$443</b>
	<b>612A</b> 2-3/4" Backset & ASA Strike			
	<b>613</b> 3-3/4" Backset & T-Strike			
	<b>613A</b> 3-3/4" Backset & ASA Strike			
	<b>615</b> 5" Backset & T-Strike			
	<b>615A</b> 5" Backset & ASA Strike			
	<b>617</b> 7" Backset & T-Strike	<b>\$323</b>	<b>\$423</b>	<b>\$480</b>
<b>617A</b> 7" Backset & ASA Strike				
<b>6200-B</b> <b>6200-C</b>  • SEC Security Screws Provided Standard - No Charge	<b>6200 Series - Cylindrical - Asylum Specify "B" or "C" Knob (Suffix)</b>	<b>US32D</b>	<b>US26D, US10, US10B, US4</b>	<b>US26, US3,US32</b>
	<b>622</b> 2-3/4" Backset & T-Strike	<b>\$270</b>	<b>\$365</b>	<b>\$419</b>
	<b>622A</b> 2-3/4" Backset & ASA Strike			
	<b>623</b> 3-3/4" Backset & T-Strike			
	<b>623A</b> 3-3/4" Backset & ASA Strike			
	<b>625</b> 5" Backset & T-Strike			
	<b>625A</b> 5" Backset & ASA Strike			
	<b>627</b> 7" Backset & T-Strike	<b>\$307</b>	<b>\$402</b>	<b>\$456</b>
<b>627A</b> 7" Backset & ASA Strike				
<b>6400</b> 	<b>6400 Series - Cylindrical Privacy - Pull Side Lock</b>	<b>US32D</b>	<b>US26D, US10, US10B, US4</b>	<b>US26, US3,US32</b>
	<b>642</b> 2-3/4" Backset & T-Strike	<b>\$364</b>	<b>\$492</b>	<b>\$565</b>
	<b>642A</b> 2-3/4" Backset & ASA Strike			
	<b>643</b> 3-3/4" Backset & T-Strike			
	<b>643A</b> 3-3/4" Backset & ASA Strike			
	<b>645</b> 5" Backset & T-Strike			
	<b>645A</b> 5" Backset & ASA Strike			
	<b>647</b> 7" Backset & T-Strike	<b>\$401</b>	<b>\$529</b>	<b>\$602</b>
<b>647A</b> 7" Backset & ASA Strike				
<b>6500</b> 	<b>6500 Series - Cylindrical Privacy - Push Side Lock</b>	<b>US32D</b>	<b>US26D, US10, US10B, US4</b>	<b>US26, US3,US32</b>
	<b>652</b> 2-3/4" Backset & T-Strike	<b>\$364</b>	<b>\$492</b>	<b>\$565</b>
	<b>652A</b> 2-3/4" Backset & ASA Strike			
	<b>653</b> 3-3/4" Backset & T-Strike			
	<b>653A</b> 3-3/4" Backset & ASA Strike			
	<b>655</b> 5" Backset & T-Strike			
	<b>655A</b> 5" Backset & ASA Strike			
	<b>657</b> 7" Backset & T-Strike	<b>\$401</b>	<b>\$529</b>	<b>\$602</b>
<b>657A</b> 7" Backset & ASA Strike				

\*\* Available on Target 1 – Quick Ship Program – See page 3 for details.

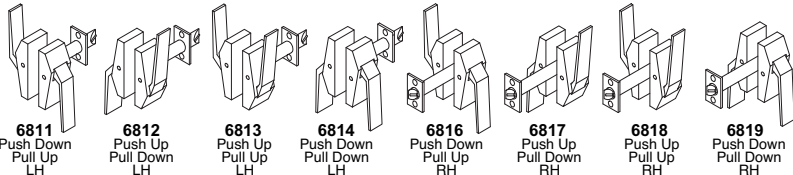
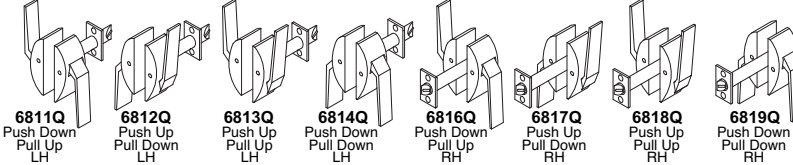
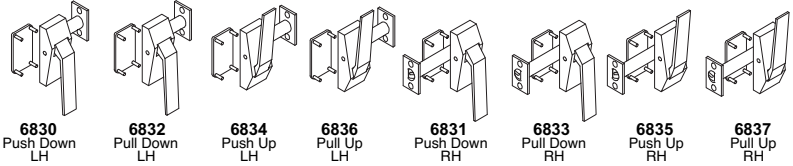
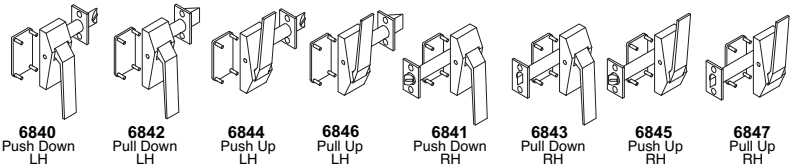
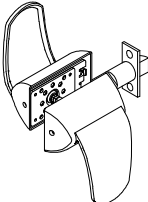
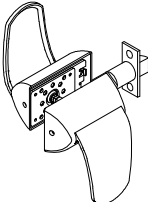

# PUSH/PULL LATCHES - CYLINDRICAL LOW PROFILE & LIGATURE-RESISTANT

<b>6800** Series - Low Profile (Specify Backset &amp; Strike)</b> 	<b>US32D</b>	<b>US26D, US10, US10B, US4</b>	<b>US26, US3, US32</b>
Supplied with 2-3/4", 3-3/4" or 5" Latch			
\$226**	\$316	\$361	
Supplied with 7" Latch			
\$263	\$353	\$398	
<b>6800Q** Series - Quiet (Specify Backset &amp; Strike)</b> <ul style="list-style-type: none"> <li>• Quiet Latch for increased patient satisfaction!</li> <li>• "RC" Round Cover Option comes standard</li> </ul> 	<b>US32D</b>	<b>US26D, US10, US10B, US4</b>	<b>US26, US3, US32</b>
Supplied with 2-3/4", 3-3/4" or 5" Latch			
\$276**	\$366	\$411	
Supplied with 7" Latch			
\$313	\$403	\$448	
<b>6830 Series - Reverse Latch (Specify Backset &amp; Strike)</b> 	<b>US32D</b>	<b>US26D, US10, US10B, US4</b>	<b>US26, US3, US32</b>
Supplied with 2-3/4", 3-3/4" or 5" Latch			
\$286	\$386	\$443	
Supplied with 7" Latch			
\$323	\$423	\$480	
<b>6840 Series - Exit Only - Low Profile (Specify Backset &amp; Strike)</b> 	<b>US32D</b>	<b>US26D, US10, US10B, US4</b>	<b>US26, US3, US32</b>
Supplied with 2-3/4", 3-3/4" or 5" Latch			
\$192	\$269	\$308	
Supplied with 7" Latch			
\$229	\$306	\$345	
<b>LR6000 Series</b> <ul style="list-style-type: none"> <li>• Mortise Versions Available (see page 9 for details)</li> <li>• Ligature-Resistant Design</li> <li>• Specify Backset &amp; Strike</li> </ul> 	<b>US32D</b>	<b>US26D, US10, US10B, US4</b>	<b>US26, US3, US32</b>
Supplied with 2-3/4", 3-3/4" or 5" Latch			
\$276	\$371	\$424	
Supplied with 7" Latch			
\$313	\$408	\$461	
<b>LR6000Q Series - Ligature-Resistant - Quiet</b> <ul style="list-style-type: none"> <li>• Quiet Latch for increased patient satisfaction!</li> <li>• Ligature-Resistant Design</li> <li>• Specify Handing, Backset &amp; Strike</li> </ul> 	<b>US32D</b>	<b>US26D, US10, US10B, US4</b>	<b>US26, US3, US32</b>
Supplied with 2-3/4", 3-3/4" or 5" Latch			
\$326	\$421	\$474	
Supplied with 7" Latch			
\$363	\$458	\$511	

\*\* Available on Target 1 – Quick Ship Program – See page 3 for details.

## How to Order:

### Model

• 6811 • 6812 • 6813 • 6814  
• 6816 • 6817 • 6818 • 6819

### Latch Backset

• 2 = 2-3/4" • 5 = 5" • 3 = 3-3/4" • 7 = 7"

### Strike

• T = 2-3/4" T-Strike • A = 4-7/8" ASA Strike

### Finish

• US32D • US32 • US10B • US3  
• US26D • US26 • US10 • US4

### Options, if Needed

(See pages 9-10 for details)

Example: 6811 – 2 A – US32D – AM

Innovation, Quality, Customer Service ...



Makes Life Simple

2/6/17





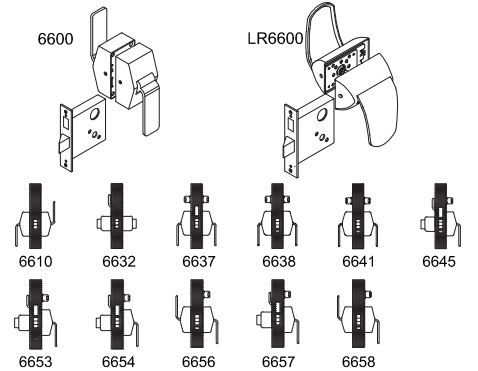
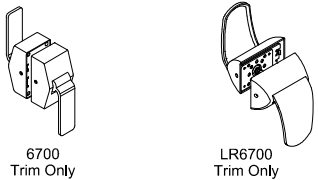

# PUSH/PULL LATCHES - MORTISE LOCK, TRIMS & OPTIONS

<b>6600 Series</b> <b>LR6600 Ligature-Resistant Series</b> • Push/Pull Trim with Mortise Lock Body	Mortise Lock Body Function	LR6600 Series	6600 Series	US32D	US26D, US10, US10B, US4	US26, US3, US32				
	Passage	LR6610	6610	\$648	\$810	\$907				
	Privacy	LR6632	6632							
	Communicating	LR6637	6637							
	Public Entrance	LR6638	6638							
	Institution	LR6641	6641							
	Hotel	LR6645	6645							
	Dormitory	LR6653	6653							
	Entry/Office	LR6654	6654							
	Classroom	LR6656	6656							
	Dormitory	LR6657	6657							
	Storeroom	LR6658	6658							
	Cylinders & cams not provided. If required, handle must be mounted in down or horizontal position.									
	<b>6700 Series</b> <b>LR6700 Ligature-Resistant Series</b> • Push/Pull Trim Only for Other Manufacturers' Mortise Lock Body (Lock Body Not Provided) • Great for Retrofit Application	Mortise Lock Manufacturer	LR6700 Series				6700 Series	US32D	US26D, US10, US10B, US4	US26, US3, US32
	Best®, Dorma®, Falcon®, Marks®	LR6710	6710	\$370	\$500	\$574				
	Schlage®	LR6720	6720							
	Yale®	LR6730	6730							
	Corbin Russwin®	LR6740	6740							
	Sargent®	LR6750	6750							
	PDQ®	LR6760	6760							
	Arrow®	LR6770	6770							
Options - Push/Pull Latches					List Add					
<b>SEC</b>	Security fasteners for all exposed screws			\$25						
<b>THICK</b>	For 1-3/8" or 2-1/4" thick door (Mortise only offered for 2-1/4")			\$70						
<b>L</b>	Lead provided to cover cut-outs made in lead-lined doors			\$70 - Cylindrical \$178 - Mortise						
<b>AM</b>	Anti-microbial clear coating applied to handles and covers			\$35						
<b>CN</b>	Copper/Nickel Natural Anti-microbial metal alloy provided for handles and covers			\$250 - LR Series \$165 - 6800 Series						
<b>EL</b>	Electrically Locking Mortise Lock Body (6641, 6658, LR6641 & LR6658 only)			\$500						
<b>EU</b>	Electrically Unlocking Mortise Lock Body (6641, 6658, LR6641 & LR6658 only)			\$500						
<b>RX</b>	Request to Exit for electrified mortise locks			\$275						
<b>H</b>	Hip Paddle for Push Side Only			\$195						
<b>EX</b>	6" Solid Extended Handle ( <b>Specify Push or Pull</b> )			\$195						
<b>X</b>	Aluminum Slip-On Handle Extension			\$175						
<b>PL</b>	Exit Only plate on push side & standard Push/Pull trim on pull side			Deduct \$40						
<b>PS</b>	Exit Only plate on pull side & standard Push/Pull trim on push side			Deduct \$40						
<b>M</b>	Security Plate for Exit Only to prevent latch tampering			\$40						
<b>AB</b>	Asylum Knob on both door sides - 6200, 6600 & 6700 models ( <b>Specify B or C Knob</b> )			\$80						
<b>PLA</b>	Push/Pull Trim on pull side and Asylum Knob on push side ( <b>Specify B or C Knob</b> )			\$50						
<b>PSA</b>	Push/Pull Trim on push side and Asylum Knob on pull side ( <b>Specify B or C Knob</b> )			\$50						
<b>FM</b>	Flush Mount Asylum Trim (cylindrical latch only)			\$500 - Single Side \$800 - Both Sides						
<b>J</b>	Junior Cover 3-1/2" x 2-3/4"			N/C						
<b>RC</b>	Round Covers (Standard for 6800Q model)			N/C						
<b>F</b>	Flip-Up Handle for ligature-resistant on push side (LR6000, LR6600 & LR6700 only)			\$150						



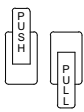
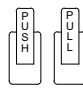
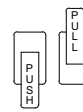
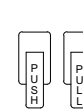
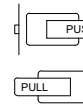
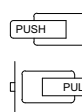
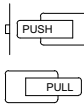
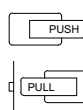



# PUSH/PULL LATCHES - ENGRAVING OPTIONS & PARTS

Standard "PUSH" & "PULL" Engraving Options = \$38 List Add (Set)  
= \$25 List Add (Single)

 <p><b>P1</b></p> <ul style="list-style-type: none"> <li>• Push Up</li> <li>• Pull Down</li> <li>• Non-handed</li> </ul>	 <p><b>P2</b></p> <ul style="list-style-type: none"> <li>• Push Up</li> <li>• Pull Up</li> <li>• Non-handed</li> </ul>	 <p><b>P3</b></p> <ul style="list-style-type: none"> <li>• Push Down</li> <li>• Pull Up</li> <li>• Non-handed</li> </ul>	 <p><b>P4</b></p> <ul style="list-style-type: none"> <li>• Push Down</li> <li>• Pull Down</li> <li>• Non-handed</li> </ul>	 <p><b>P5</b></p> <ul style="list-style-type: none"> <li>• Handle point hinge-side</li> <li>• Right Hand</li> </ul>	 <p><b>P6</b></p> <ul style="list-style-type: none"> <li>• Handle point hinge-side</li> <li>• Left Hand</li> </ul>
 <p><b>P7</b></p> <ul style="list-style-type: none"> <li>• Handles point lock-side</li> <li>• Right Hand</li> <li>• 7" backset only</li> </ul>	 <p><b>P8</b></p> <ul style="list-style-type: none"> <li>• Handle point lock-side</li> <li>• Left Hand</li> <li>• 7" backset only</li> </ul>	 <p><b>P9</b></p> <ul style="list-style-type: none"> <li>• Push Up</li> <li>• Single Handle Only</li> </ul>	 <p><b>P10</b></p> <ul style="list-style-type: none"> <li>• Push Down</li> <li>• Single Handle Only</li> </ul>	 <p><b>P11</b></p> <ul style="list-style-type: none"> <li>• Pull Up</li> <li>• Single Handle Only</li> </ul>	 <p><b>P12</b></p> <ul style="list-style-type: none"> <li>• Pull Down</li> <li>• Single Handle Only</li> </ul>

**Animal Engraving Options = \$75 List Add (Set)**

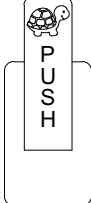
- Includes cost for "PUSH" & "PULL" engraving
- Animal engraving is done at end of handle
- Specify animal letter designation (E, F, G or T) after standard Engraving Option above (Ex: P1T, as shown)
- **Contact Factory for other custom engraving options**

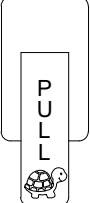
<b>E</b> = Elephant 	<b>F</b> = Fish 		<b>P1T</b>
<b>T</b> = Turtle 	<b>G</b> = Giraffe 		<ul style="list-style-type: none"> <li>• Push Up</li> <li>• Pull Down</li> <li>• Non-handed</li> <li>• Turtle</li> </ul>

Parts - Strikes	US32D	US10, US10B, US4
<b>601LB</b> Roller Latch Conversion Kit (Specify T, ASA or D)	\$35	\$40
<b>6055</b> 2-1/4" Full Lip D-Strike	\$19	\$25
<b>6058</b> 2-3/4" Standard T-Strike	\$19	\$25
<b>6059</b> 4-7/8" ASA Strike	\$19	\$25
<b>605912</b> 4-7/8" ASA Strike w/ 1-1/2" Extended Lip	\$19	\$25
<b>605958</b> 4-7/8" ASA Strike w/ 1-5/8" Extended Lip	\$19	\$25
<b>6603</b> 4-7/8" ASA Strike for Mortise Lock	\$19	\$25
<b>6059RL</b> 4-7/8" ASA Roller Strike	\$30	-
<b>6603RL</b> 4-7/8" ASA Roller Strike for Mortise Lock	\$30	-

\*\*\*\*\*Contact Factory for Any Custom Strike Requirements\*\*\*\*\*

Parts - Cylindrical Latches - US32D Finish only			
6000, 6100, 6200, 6400, 6500 & LR6000 Series			6800Q & LR6000Q Series - Quiet
<b>6275</b>	2-3/4"	\$38	<b>68275Q</b> 2-3/4" \$48
<b>6375</b>	3-3/4"	\$48	<b>68375Q</b> 3-3/4" \$48
<b>6050</b>	5"	\$48	<b>68050Q</b> 5" \$48
<b>6070</b>	7"	\$65	<b>68070Q</b> 7" \$75
6800 & 6840 Series			6830 Reverse Series
<b>68275</b>	2-3/4"	\$38	<b>683275</b> 2-3/4" \$48
<b>68375</b>	3-3/4"	\$48	<b>683375</b> 3-3/4" \$58
<b>68050</b>	5"	\$48	<b>683050</b> 5" \$58
<b>68070</b>	7"	\$65	<b>683070</b> 7" \$75

Parts	US32D	US10, US10B, US4	US3, US32
<b>6000-JIG</b> Drilling Jig (6000 Series)	\$95 (no finish required)		
<b>60101</b> Handle Spring (6000, 6100, 6400, 6500, 6600 or 6700 Series)	\$10 (no finish required)		
<b>6062</b> Handle Shaft & Cotter Pin (6000, 6100, 6400, 6500, 6600 or 6700)	\$10 (no finish required)		
<b>6004</b> Cover (6000 Series)	\$40	\$55	\$70
<b>6604</b> Cover (6100, 6600 or 6700 Series)	\$40	\$55	\$70
<b>6804</b> Cover (6800, 6830 or 6840 Series)	\$40	\$55	\$70
<b>6000-PUSH</b> Push Side Complete Assembly with Cover (6000 Series)	\$100	\$120	\$140
<b>6000-PULL</b> Pull Side Complete Assembly with Cover (6000 Series)	\$100	\$120	\$140
<b>6700-PUSH</b> Push Side Complete Assembly with Cover (6700 Series)	\$180	\$200	\$220
<b>6700-PULL</b> Pull Side Complete Assembly with Cover (6700 Series)	\$180	\$200	\$220
<b>6800-PUSH</b> Push Side Complete Assembly with Cover (6800 Series)	\$100	\$120	\$140
<b>6800-PULL</b> Pull Side Complete Assembly with Cover (6800 Series)	\$100	\$120	\$140
<b>LOCK BODY</b> Mortise Lock Body & Faceplate Only (Specify Function & Handing)	\$280	\$290	\$300



Innovation, Quality, Customer Service ...  *Makes Life Simple* 2/6/17

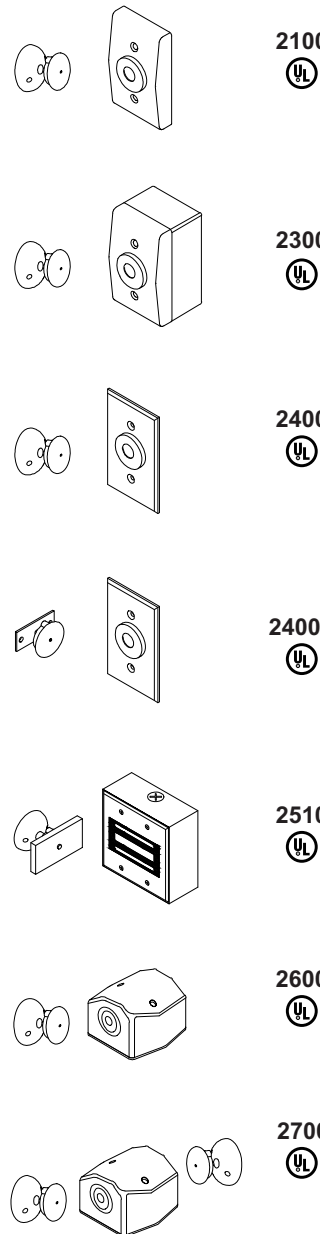

# ELECTROMAGNETIC DOOR HOLDERS

Units come standard as **tri-voltage** to be wired either 12V DC, 24V AC/DC or 120V AC.

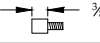
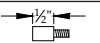
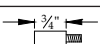
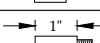
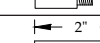
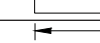

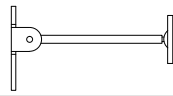
Models	US28, S1	S2, S3, S4, S5	US32D	US32
<b>2100**</b> Recessed Wall Mount with Standard Armature	\$228**	\$245	\$310	\$360
<b>2300**</b> Surface Wall Mount with Standard Armature	\$240**	\$257	\$327***	\$379***
<b>2400**</b> Flush Wall Mount with Standard Armature	\$228**	\$245	\$310	\$360
<b>2400L</b> Flush Wall Mount with Low Profile Armature	\$240	\$257	\$327	\$379
<b>2400LS</b> Flush Wall Mount with Extreme Low Profile Armature	\$240	\$257	\$327	\$379
<b>2510</b> Surface Wall Mount - Heavy Duty for 300 lbs. (24V AC/DC Only)	\$590	\$610	\$680***	\$730***
<b>2600**</b> Single Floor Mount with Standard Armature	\$505**	\$525	-	-
<b>2700</b> Double Floor Mount with 2 Standard Armatures	\$605	\$640	-	-
<b>Door Armatures &amp; Extensions</b>				
<b>20020**</b> Standard Door Armature Assembly Only - 1-5/8" Projection (2100, 2300, 2400, 2600, 2700 models)	\$80**	\$90	\$100	\$130
<b>24020</b> Low Profile Door Armature Assembly Only (2400L model)	\$85	\$95	\$105	\$135
<b>25020</b> Heavy Duty Door Armature Assembly Only (2510 model)	\$140	\$150	\$160	\$190
<b>20038**</b> 3/8" Extension 	\$24 - Zinc Plated**			
<b>20050**</b> 1/2" Extension 	\$24 - Zinc Plated**			
<b>20075**</b> 3/4" Extension 	\$24 - Zinc Plated**			
<b>2400L</b> <b>20100**</b> 1" Extension 	\$24 - Zinc Plated**			
<b>20200**</b> 2" Extension 	\$33 - Zinc Plated**			
<b>20400**</b> 4" Extension 	\$55 - Zinc Plated**			
<b>20600**</b> 6" Extension 	\$77 - Zinc Plated**			
<b>20120**</b> 1-1/2" Extension with 120° Swivel	\$48 - Zinc Plated**			
<b>S20020</b> Custom Armature with Extension for lengths greater than 10" (Specify overall length) 	Contact Factory			
<b>Parts</b>				
<b>20012</b> Wall Cover Only (2100 & 2300 models)	\$30	\$35	\$50	\$60
<b>20014</b> Wall Cover Only (2400 & 2400L models)	\$30	\$35	\$50	\$60
<b>21030</b> Wall Portion Only (2100 model)	\$80	\$85	\$100	\$110
<b>23030</b> Wall Portion Only (2300 model)	\$95	\$100	115***	125***
<b>24030</b> Wall Portion Only (2400 & 2400L models)	\$80	\$85	\$100	\$110
<b>25030</b> Wall Portion Only (2510 model)	\$240	\$245	260***	270***
<b>23005</b> 2300 Electrical Box Only	\$30	\$35	***	***
<b>25005</b> 2510 Electrical Box Only	\$40	\$45	***	***
<b>20040</b> Armature Base Only (No Head)	\$35	\$40	\$50	\$60
<b>20010</b> Armature Head Only (No Base)	\$41 - Zinc Plated			
<b>Options</b>				
<b>List Add</b>				
<b>SEC</b> Security Fasteners for All Exposed Areas	\$34			
<b>RS</b> Rocker Switch	\$250			
<b>THICK</b> Fasteners provided for 1-3/8" or 2-1/4" Thick Door	\$30			

\*\* Available on **Target 1 - Quick Ship Program** - See page 3 for details.

\*\*\* Electrical boxes are only available in US28 or painted finishes. When ordering US32D or US32, only the armature base and wall cover will be US32D or US32.



# ELECTRICAL POWER TRANSFERS

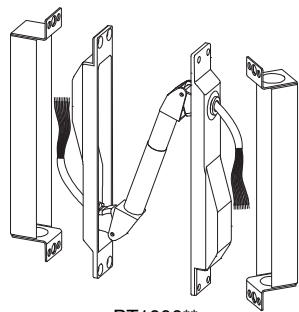

PT1000\*\*

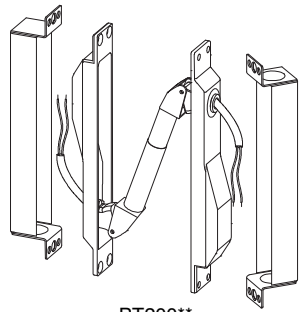

PT200\*\*

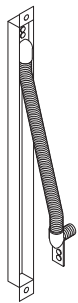

PT105\*\* / PTR180\*\*

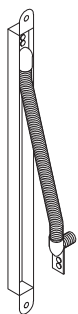

PTR105 / PTR180

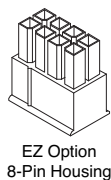

EZ Option  
8-Pin Housing

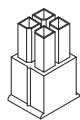

EZ Option  
4-Pin Housing

Electrical Power Transfers		US28	S2, S3, S4	S5	US32D
PT1000**	(10) 24 AWG Wires	\$340**	\$370	\$340	-
PT1000SC	(10) 24 AWG Wires For Swing Clear Application	\$460	\$490	\$460	-
PT1000EZ	(12) 24 AWG Wires with EZ Connectors Molex® Micro-Fit 3.0	\$400	\$430	\$400	-
PT1200EZ	(12) 24 AWG Wires with EZ Connectors Molex® Mini-Fit Jr.	\$400	\$430	\$400	-
PT200**	(2) 18 AWG Wires	\$340**	\$370	\$340	-
PT200EZ	(2) 18 AWG Wires w/ Molex® Connectors Molex® Micro-Fit 3.0	\$400	\$430	\$400	-
PT200SC	(2) 18 AWG Wires For Swing Clear Application	\$460	\$490	\$460	-
PTC5E	CAT-5E Ethernet Cable Wire	\$400	\$430	\$400	-
PTC6PLUS	(8) 24 AWG Wires & (1) 22 AWG Wire Stranded Ethernet Cable (1 - 250 MHz)	\$400	\$430	\$400	-
PT105**	105° Door Swing - Square Corners (No Wire Provided - See Options Below)	-	\$125	\$125	\$95**
PTR105	105° Door Swing - Rounded Corners (No Wire Provided - See Options Below)	-	\$125	\$125	\$95
PT180**	180° Door Swing - Square Corners (No Wire Provided - See Options Below)	-	\$145	\$145	\$115**
PT180SC	180° Door Swing - Square Corners For Swing Clear Application (No Wire Provided - See Options Below)	-	\$145	\$145	\$115**
PTR180	180° Door Swing - Rounded Corners (No Wire Provided - See Options Below)	-	\$145	\$145	\$115
PTR180SC	180° Door Swing - Rounded Corners For Swing Clear Application (No Wire Provided - See Options Below)	-	\$145	\$145	\$115**
PTS105	Security Bracket for PT105	-	\$42	\$42	\$22
PTS180	Security Bracket for PT180	-	\$42	\$42	\$22

Options - Electrical Power Transfers		List Add
SEC	Security Fasteners provided for all exposed screws	\$25
2WIRE	Add (2) 18 AWG Wires (PT105, PTR105, PT180 or PTR180 models)	\$100
10WIRE	Add (10) 24 AWG Wires (PT105, PTR105, PT180 or PTR180 models)	\$100
2WIRE-EZ	Add (2) 18 AWG Wires with Molex® Micro-Fit 3.0 EZ Connectors (PT105, PTR105, PT180 or PTR180 models)	\$160
10WIRE-EZ	Add (10) 24 AWG Wires with Molex® Micro-Fit 3.0 EZ Connectors (PT105, PTR105, PT180 or PTR180 models)	\$160

\*\* Available on Target 1 - Quick Ship Program - See page 3 for details.

Innovation, Quality, Customer Service ... **A:H**® *Makes Life Simple* 2/6/17



# COORDINATORS

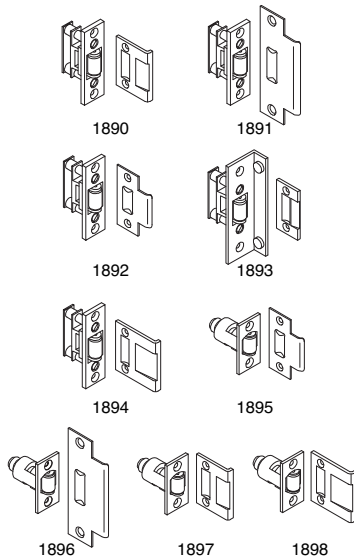
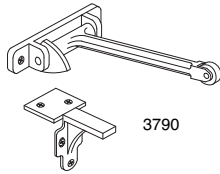
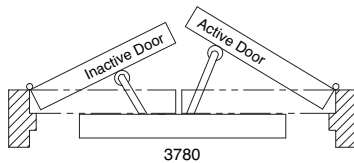
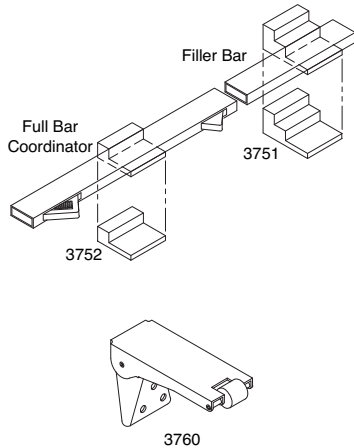

Coordinators - Full Bar						
Model	Door Frame Opening (Equal Pair)	Coordinator Length	Filler Bar Length	US28, S1	S2, S3, S4, S5, S8	USP
3711	52" or Less	32"	20"	\$93	\$118	\$118
3712	52-1/16" - 56"	32"	32"	\$93	\$118	\$118
3721**	56-1/16" - 72"	52"	20"	\$93**	\$118	\$118
3722	72-1/16" - 84"	52"	32"	\$101	\$126	\$126
3723	84-1/16" - 96"	52"	44"	\$109	\$134	\$134
3733	96-1/16" - 104"	60"	44"	\$125	\$150	\$150
3741	<b>Unequal Pair</b> 36" Active & 12"- 24" Inactive	42"	20"	\$100	\$125	\$125

Coordinators	US32D	US28, S1	S2, S3, S4, S5, S8	USP
3751** Mounting Bracket for Stop less than 2-1/2"	-	\$20**	\$30	\$30
3752** Mounting Bracket for Stop 2-1/2" or greater	-	\$20**	\$30	\$30
3760 Carry Bar	-	\$45	\$45	\$28
3780** Universal Coordinator - 20"	-	\$110	\$110	\$85**
3790 Gravity Coordinator - 7" Arm	\$88	-	-	-

Parts - Coordinators	US28, S1	S2, S3, S4, S5, S8	USP
3701 20" Filler Bar Only	\$30	\$35	\$35
3702 32" Filler Bar Only	\$35	\$40	\$40
3703 44" Filler Bar Only	\$40	\$45	\$45

Roller Latches	US32D	US10*, US10B*, US3*, US32*, US4*
1890** 5/16" Max. Projection & Cast Strike	\$54**	\$62
1890S 5/16" Max. Projection & Custom Strike	Call Factory	
1891 5/16" Max. Projection & ASA Strike	\$61	\$70
1892 5/16" Max. Projection & T - Strike	\$54	\$62
1893 Integrated Angle Stop & Cast Strike	\$106	\$121
1894 5/16" Max. Projection & Extended Cast Strike	\$61	\$70
1895** 1/2" Max. Projection & T - Strike	\$72**	\$83
1896 1/2" Max. Projection & ASA Strike	\$80	\$92
1897 1/2" Max. Projection & Cast Strike	\$72	\$83
1898 1/2" Max. Projection & Extended Cast Strike	\$82	\$94

\* Roller Latch Faceplate is only provided in US32D (except 1893).  
Strikes only will be provided in finish ordered.

\*\* Available on Target 1 - Quick Ship Program - See page 3 for details.



# FLUSH BOLTS

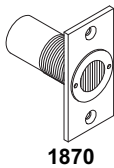
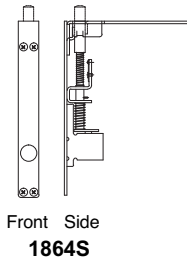
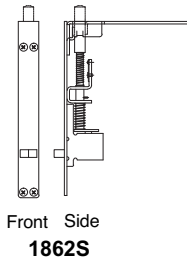
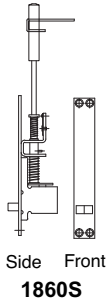
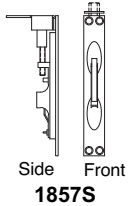
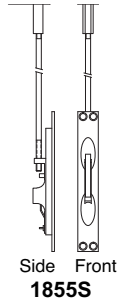

Manual Flush Bolts		US32D, US26D	US10, US10B, US3, US32, US4
<b>1854</b>	Metal Door, Manual Top Bolt & Bottom Fire Bolt	\$80	\$97
<b>1855S</b>	Metal Door, Single	\$15**	\$18
<b>1855P</b>	Metal Door, Pair	\$30**	\$36
<b>1856</b>	Wood Door, Manual Top Bolt & Bottom Fire Bolt	\$90	\$107
<b>1857S</b>	Wood Door, Single	\$25**	\$30
<b>1857P</b>	Wood Door, Pair	\$50**	\$60
Bottom Fire Bolt		US32D, US26D	US10, US10B, US3, US32, US4
<b>1858</b>	Universal for Metal or Wood Door	\$68	\$82
Automatic Flush Bolts		US32D**, US26D	US10, US10B, US3, US32, US4
<b>1860S**</b>	Metal Door, Single	\$72**	\$83
<b>1860P**</b>	Metal Door, Pair	\$129**	\$148
<b>1861S</b>	Universal for Metal or Wood Door, Single	\$92	\$100
<b>1861P</b>	Universal for Metal or Wood Door, Pair	\$165	\$190
<b>1862S**</b>	Wood Door, Single	\$76**	\$87
<b>1862P**</b>	Wood Door, Pair	\$137**	\$158
<b>1867</b>	Metal Door, Automatic Top Bolt & Bottom Fire Bolt	\$129	\$148
<b>1868</b>	Wood Door, Automatic Top Bolt & Bottom Fire Bolt	\$137	\$158
<b>1869</b>	Universal Top Bolt for Metal or Wood Door & Bottom Fire Bolt	\$165	\$190
Self-Latching & Combination Flush Bolts		US32D, US26D	US10, US10B, US3, US32, US4
<b>1863S</b>	Metal Door, Single Self-Latching Top Bolt	\$72	\$83
<b>1863P</b>	Metal Door, Self-Latching Top Bolt & Automatic Bottom Bolt	\$129	\$148
<b>1864S</b>	Wood Door, Single Self-Latching Top Bolt	\$76	\$87
<b>1864P</b>	Wood Door, Self-Latching Top Bolt & Automatic Bottom Bolt	\$137	\$158
<b>1865</b>	Metal Door, Self-Latching Top Bolt & Bottom Fire Bolt	\$129	\$148
<b>1866</b>	Wood Door, Self-Latching Top Bolt & Bottom Fire Bolt	\$137	\$158
Dust Proof Strike		US32D**, US26D	US10, US10B, US3, US32, US4
<b>1870</b>	With Removeable Section for Use with Threshold	\$16**	\$19
Options - Flush Bolts		List Add	
<b>EXT-18</b>	18" Rod Extension	\$15	
<b>EXT-24</b>	24" Rod Extension	\$20	
<b>EXT-30</b>	30" Rod Extension	\$25	
<b>EXT-36</b>	36" Rod Extension	\$30	
<b>EXT-48</b>	48" Rod Extension	\$35	
<b>SEC</b>	Security Fasteners for All Exposed Fasteners	\$30	

\*\* Available on Target 1 – Quick Ship Program – See page 3 for details.

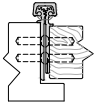
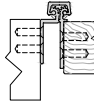

# ALUMINUM CONTINUOUS GEARED HINGES

 <b>All Aluminum Hinges available on 48 Hour Quick Ship</b>		A110HD	A110WTHD	A111HD	A111WTHD	A130HD	A140HD
		 • No Inset	 • No Inset • Wide Throw	 • 1/8" Inset	 • 1/8" Inset • Wide Throw	 • 1/16" Inset Safety Hinge	 • 3/32" Inset • Door Lip Protector
79", 83", 85"	Clear	\$119	\$299	\$119	\$299	\$154	\$119
	Dark Bronze	\$152	\$383	\$152	\$383	\$197	\$152
	Black	\$175	\$440	\$175	\$440	\$227	\$175
95"	Clear	\$155	\$389	\$155	\$389	\$200	\$155
	Dark Bronze	\$198	\$498	\$198	\$498	\$256	\$198
	Black	\$228	\$573	\$228	\$573	\$294	\$228
120"	Clear	\$226	\$568	\$226	\$568	\$293	\$226
	Dark Bronze	\$289	\$727	\$289	\$727	\$375	\$289
	Black	\$332	\$836	\$332	\$836	\$431	\$332

For Lead-Linked Doors							
		A110LL	A110WTHD comes standard with "LL" mounting hole pattern to help carry the load	A111LL	A111WTHD comes standard with "LL" mounting hole pattern to help carry the load	A130LL	A140LL
79", 83", 85"	Clear	\$150		\$150		\$186	\$150
	Dark Bronze	\$193		\$193		\$238	\$193
	Black	\$222		\$222		\$274	\$222
95"	Clear	\$196		\$196		\$242	\$196
	Dark Bronze	\$250		\$250		\$310	\$250
	Black	\$288		\$288		\$356	\$288
120"	Clear	\$286		\$286		\$355	\$286
	Dark Bronze	\$366		\$366		\$454	\$366
	Black	\$421	\$421	\$522	\$421		

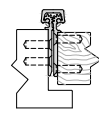
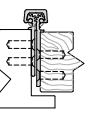
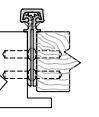
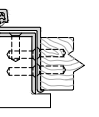

# ALUMINUM CONTINUOUS GEARED HINGES

<div style="text-align: center;">  <p><b>All Aluminum Hinges available on 48 Hour Quick Ship</b></p> </div> <div style="text-align: center;"> <p><b>Full Concealed Models</b></p> </div>		A150HD	A160HD	A240HD	A260HD	A270HD	A410HD
		 <ul style="list-style-type: none"> <li>• No Inset</li> <li>• For use with Kawneer®</li> </ul>	 <ul style="list-style-type: none"> <li>• 3/32" Inset</li> </ul>	 <ul style="list-style-type: none"> <li>• 3/32" Inset</li> <li>• Door Lip Protector</li> </ul>	 <ul style="list-style-type: none"> <li>• 3/32" Inset</li> <li>• 2" Thick Door</li> </ul>	 <ul style="list-style-type: none"> <li>• No Inset</li> <li>• 2" Thick Door</li> </ul>	 <ul style="list-style-type: none"> <li>• No Inset</li> <li>• Swing Clear</li> </ul>
79", 83", 85"	Clear	\$119	\$119	\$119	\$130	\$130	\$226
	Dark Bronze	\$152	\$152	\$152	\$166	\$166	\$289
	Black	\$175	\$175	\$175	\$191	\$191	\$332
95"	Clear	\$155	\$155	\$155	\$169	\$169	\$274
	Dark Bronze	\$198	\$198	\$198	\$216	\$216	\$376
	Black	\$228	\$228	\$228	\$248	\$248	\$432
120"	Clear	\$226	\$226	\$226	\$247	\$247	\$429
	Dark Bronze	\$289	\$289	\$289	\$316	\$316	\$550
	Black	\$332	\$332	\$332	\$363	\$363	\$632

For Lead-Lined Doors							
		A150LL	A160LL	A240LL	A260LL	A270LL	A410LL
79", 83", 85"	Clear	\$150	\$150	\$150	\$154	\$154	\$256
	Dark Bronze	\$193	\$193	\$193	\$197	\$197	\$328
	Black	\$222	\$222	\$222	\$227	\$227	\$377
95"	Clear	\$196	\$196	\$196	\$200	\$200	\$333
	Dark Bronze	\$250	\$250	\$250	\$256	\$256	\$426
	Black	\$288	\$288	\$288	\$294	\$294	\$490
120"	Clear	\$286	\$286	\$286	\$293	\$293	\$486
	Dark Bronze	\$366	\$366	\$366	\$375	\$375	\$623
	Black	\$421	\$421	\$421	\$431	\$431	\$716



# ALUMINUM CONTINUOUS GEARED HINGES

**All Aluminum Hinges available on 48 Hour Quick Ship**

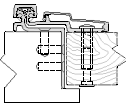
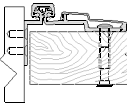
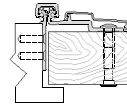
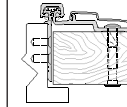
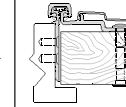
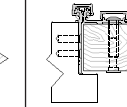
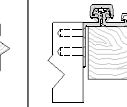
Half Surface Models		A211HD	A213HD	A450HD	A460HD	A530HD	A540HD	A550HD
		 • 1/16" Inset • Swing Clear	 • Center Hung Doors	 • 9/32" Inset	 • 9/32" Inset	 • 3/32" Inset	 • 3/32" Inset	 • Double Egress and Center Hung Doors
79", 83", 85"	Clear	\$330	\$241	\$271	\$271	\$186	\$186	\$215
	Dark Bronze	\$422	\$308	\$347	\$347	\$238	\$238	\$275
	Black	\$485	\$354	\$399	\$399	\$274	\$274	\$316
95"	Clear	\$429	\$313	\$352	\$352	\$242	\$242	\$280
	Dark Bronze	\$549	\$401	\$451	\$451	\$310	\$310	\$358
	Black	\$631	\$461	\$519	\$519	\$356	\$356	\$412
120"	Clear	\$627	\$458	\$515	\$515	\$353	\$353	\$409
	Dark Bronze	\$803	\$586	\$659	\$659	\$452	\$452	\$523
	Black	\$923	\$674	\$758	\$758	\$520	\$520	\$601

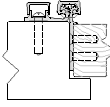
Half Mortise Models		A520HD	Full Surface Models				
		 • 5/64" Inset				A210HD	A570HD
79", 83", 85"	Clear	\$186	79", 83", 85"	Clear	\$184	\$184	\$184
	Dark Bronze	\$238		Dark Bronze	\$236	\$236	\$236
	Black	\$274		Black	\$271	\$271	\$271
95"	Clear	\$242	95"	Clear	\$239	\$239	\$239
	Dark Bronze	\$310		Dark Bronze	\$306	\$306	\$306
	Black	\$356		Black	\$352	\$352	\$352
120"	Clear	\$353	120"	Clear	\$350	\$350	\$350
	Dark Bronze	\$452		Dark Bronze	\$447	\$447	\$447
	Black	\$520		Black	\$514	\$514	\$514



# ALUMINUM CONTINUOUS GEARED HINGES

How to Order - Aluminum Geared Hinges		
<b>Model</b> _____ <b>Grade</b> _____ • HD = Heavy Duty • LL = Heavy Duty, for Lead-Lined Door		<b>Example: A110 HD C 083 x PT</b> ↑ ↑ ↑ ↑ ↑ <b>Options, if Applicable</b>
<b>Finish</b> _____ • B = Black Anodized • C = Clear Anodized • D = Dark Bronze Anodized		<b>Hinge Height</b> _____ • 079 = 79" • 083 = 83" • 085 = 85" • 095 = 95" • 120 = 120"
Electrical Options - Aluminum Geared Hinges		List Add
<b>TW4</b>	(4) 30 AWG Wires for Concealed Electrification	\$210
<b>TW8</b>	(8) 30 AWG Wires for Concealed Electrification	\$250
<b>TW12</b>	(12) 30 AWG Wires for Concealed Electrification	\$300
<b>EZ4</b>	(4) 30 AWG Wires with Molex® MicroFit 3.0 Connectors for Concealed Electrification	\$280
<b>EZ8</b>	(8) 30 AWG Wires with Molex® MicroFit 3.0 Connectors for Concealed Electrification	\$320
<b>EZ12</b>	(12) 30 AWG Wires with Molex® MicroFit 3.0 Connectors for Concealed Electrification	\$370
<b>M</b>	Moveable Electrical Access Prep for Electrified Portion (Serviceable)	\$110
<b>R</b>	Removeable Electrical Access Prep for Electrified Portion (Accessible)	\$110
<b>PT</b>	Electrical Power Transfer Prep (Specify Electrical Power Transfer Model & Location)	\$80
<b>EC</b>	Exposed Electrical Contact - Specify Number of Contacts Required (2 minimum)	\$80 each
<b>EM</b>	Concealed Electrical Magnetic Monitoring Switch	\$200
<b>ES</b>	Exposed Electrical Monitoring Switch	\$90
<b>MT4</b>	(4) 30 AWG Wires for Concealed Electrification & Concealed Monitoring Switch	\$300
<b>MT8</b>	(8) 30 AWG Wires for Concealed Electrification & Concealed Monitoring Switch	\$350
<b>MT12</b>	(12) 30 AWG Wires for Concealed Electrification & Concealed Monitoring Switch	\$400
Non-Electrical Options - Aluminum Geared Hinges		List Add
<b>FR</b>	Stainless Steel Fire Studs for 3-Hour UL Listing (ABH Standard = 90 Minute - No Charge)	\$50
<b>HT</b>	Hospital Tip for Full Concealed Models (Specify Handing)	\$70
<b>HT</b>	Hospital Tip for Half Surface & Full Surface Models (Specify Handing)	\$100
<b>DD</b>	Dutch Door Prep	\$80
<b>SEC</b>	Security Fasteners for all Exposed Fasteners (Specify Door & Frame Material)	\$45
<b>CUT</b>	Cut to Custom Length (Specify Length & Handing)	No Charge
<b>TR</b>	Tamper-Resistant (Hospital Tip & Every Other Bearing has a Set Screw)	\$40
<b>SC</b>	School Cap	\$40
<b>SPLICE</b>	120-1/8" - 144" Long Hinge (Specify Length & Handing)	120" List Price + 120" List Price + \$90 List
<b>LL</b>	Lead-Lined Cover (Half Surface & Full Surface - Door Leaf Only)	\$80
<b>SL</b>	Sheared Leaf for 1-3/8" Door (Concealed Leaf Only)	\$50
<b>1-3/8"</b>	Shortened Sex Bolts for 1-3/8" Door (Half Surface & Full Surface)	\$20
<b>CUSTOM HOLE</b>	Custom Hole Patterns	Contact Factory
Other Finishes - Aluminum Geared Hinges		List Add
<b>CUSTOM ANODIZING</b>	Specify color - Requires customer color sample approval	Contact Factory
<b>POWDER COAT</b>	Specify color - Requires customer color sample approval	Contact Factory



# ALUMINUM CONTINUOUS GEARED HINGES - PARTS

Parts - Aluminum Geared Hinges		List Price
R-TW4	4" Removable Section Only - (4) 30 AWG Wires (Specify Hinge Model)	\$210
R-TW8	4" Removable Section Only - (8) 30 AWG Wires (Specify Hinge Model)	\$250
R-TW12	4" Removable Section Only - (12) 30 AWG Wires (Specify Hinge Model)	\$300
GHSIM-83-063	Shim - 1/16" thick x 1-1/2" wide x 83" long, aluminum, clear anodized	\$30
GHSIM-83-125	Shim - 1/8" thick x 1-1/2" wide x 83" long, aluminum, mill finish	\$40
GHSIM-120-063	Shim - 1/16" thick x 1-1/2" wide x 120" long, aluminum, clear anodized	\$60
GHSIM-120-125	Shim - 1/8" thick x 1-1/2" wide x 120" long, aluminum, mill finish	\$85



Parts (Fasteners) - Aluminum Geared Hinges		List Price
SCREW PACK	Full Concealed Standard Screw Pack (specify wood or metal, finish, hinge model and hinge length)	\$45
SCREW PACK	Half Surface or Full Surface Screw Pack (specify wood or metal, finish, hinge model and hinge length)	\$45
SCREW PACK - SEC	Screw Pack with Security Fasteners (specify wood or metal, finish, hinge model and hinge length)	\$45
GH1224FHSDS-500-C	(500) 12-24 x 7/8" Phillips flat head, undercut self-drilling, thread-forming tek machine screws, for clear hinges	\$200
GH1224FHSDS-500-D	(500) 12-24 x 7/8" Phillips flat head, undercut self-drilling, thread-forming tek machine screws, for dark bronze or black hinges	\$200
GH12FHWS-500-C	(500) #12 x 1-1/2" Phillips flat head, undercut wood screws, for clear hinges	\$200
GH12FHWS-500-D	(500) #12 x 1-1/2" Phillips flat head, undercut wood screws, for dark bronze or black hinges	\$200
GH1224FHWSSEC-500-C	(500) #12 x 1-1/2" Pin-in torx flat head, undercut wood security screws, for clear hinges	\$300
GH1224FHWSSEC-500-D	(500) #12 x 1-1/2" Pin-in torx flat head, undercut wood security screws, for dark bronze or black hinges	\$300
GH1224FHSDSSEC-500-C	(500) 12-24 x 7/8" Pin-in torx flat head, undercut self-drilling, thread-forming tek machine security screws, for clear hinges	\$300
GH1224FHSDSSEC-500-D	(500) 12-24 x 7/8" Pin-in torx flat head, undercut self-drilling, thread-forming tek machine security screws, for dark bronze or black hinges	\$300
GH1224RHSDS-500	(500) 12-24 x 7/8" Phillips round head self-drilling, thread-forming tek machine screws, zinc plated	\$200

Parts - Aluminum Geared Hinges	Nominal Door Height	Net Hinge Height	List Price Clear	List Price Dark Bronze or Black
A04 - Door Leaf Cover for A210, A213, A450 & A460 A09 - Frame Leaf Cover for A570 A10 - Door Leaf Cover for A530, A540, A550, A570 & A571	6'8"	79"	\$41	\$45
	7'0"	83"		
	7'2"	85"		
	8'0"	95"	\$45	\$54
	10'0"	120"	\$54	\$63



# STAINLESS STEEL PIN & BARREL CONTINUOUS HINGES – CONCEALED

- “Nominal Door Height” refers to the distance between the frame head and the bottom of the frame.
- “Actual Hinge Height” refers to the actual height of the hinge supplied by ABH® (custom heights available).

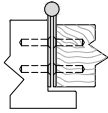
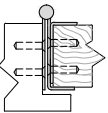
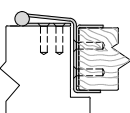
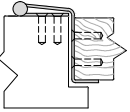
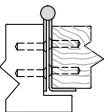
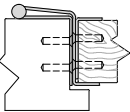
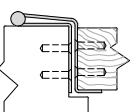
Full Concealed - 14 Gauge		Nominal Door Height	Net Hinge Height	US32D
 <p><b>UL</b> <b>A500**</b></p> <ul style="list-style-type: none"> <li>• 1/8" Inset</li> </ul>	6'8"	78-3/4"	\$339**	
	7'0"	83-1/8"***		
	7'2"	85"	\$424	
	8'0"	95"		
	10'0"	118-3/4"	\$509	
 <p><b>UL</b> <b>A505**</b></p> <ul style="list-style-type: none"> <li>• Flush Mount, No Inset</li> <li>• Door Edge Guard on Both Faces of Door</li> <li>• Adjustable Studs Optional (Page 23)</li> </ul>	6'8"	78-3/4"	\$463**	
	7'0"	83-1/8"***		
	7'2"	85"	\$578	
	8'0"	95"		
	10'0"	118-3/4"	\$694	
 <p><b>UL</b> <b>A510</b></p> <ul style="list-style-type: none"> <li>• Swing Clear</li> <li>• Flush Mount, No Inset</li> <li>• Door Edge Guard on Both Faces of Door</li> <li>• Adjustable Studs Optional (Page 23)</li> </ul>	6'8"	78-3/4"	\$568	
	7'0"	83-1/8"		
	7'2"	85"	\$653	
	8'0"	95"		
	10'0"	118-3/4"	\$746	
 <p><b>UL</b> <b>A511**</b></p> <ul style="list-style-type: none"> <li>• Swing Clear</li> <li>• Flush Mount, No Inset</li> <li>• Door Edge Guard on Stop Side Only</li> </ul>	6'8"	78-3/4"	\$406**	
	7'0"	83-1/8"***		
	7'2"	85"	\$507	
	8'0"	95"		
	10'0"	118-3/4"	\$608	
 <p><b>UL</b> <b>A515**</b></p> <ul style="list-style-type: none"> <li>• Full Concealed</li> <li>• Flush Mount, No Inset</li> <li>• Door Edge Guard on Stop Side Only</li> </ul>	6'8"	78-3/4"	\$414**	
	7'0"	83-1/8"***		
	7'2"	85"	\$517	
	8'0"	95"		
	10'0"	118-3/4"	\$620	
 <p><b>UL</b> <b>A526</b></p> <ul style="list-style-type: none"> <li>• Flush Mount, No Inset</li> <li>• Swing Clear</li> <li>• Door Edge Guard on Both Faces of Door</li> <li>• Adjustable Studs Optional (Pg. 23)</li> </ul>	6'8"	78-3/4"	\$688	
	7'0"	83-1/8"		
	7'2"	85"	\$798	
	8'0"	95"		
	10'0"	118-3/4"	\$957	
 <p><b>UL</b> <b>A529</b></p> <ul style="list-style-type: none"> <li>• Flush Mount, No Inset</li> <li>• Swing Clear</li> <li>• Door Edge Guard on Stop Side Only</li> </ul>	6'8"	78-3/4"	\$644	
	7'0"	83-1/8"		
	7'2"	85"	\$743	
	8'0"	95"		
	10'0"	118-3/4"	\$891	

\*\* Available on Target 1 – Quick Ship Program – See page 3 for details.

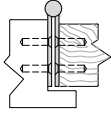
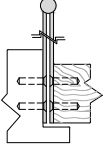
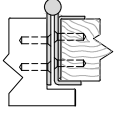
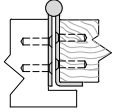
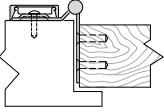
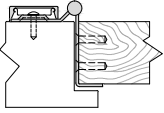
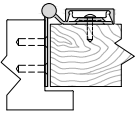

# STAINLESS STEEL PIN & BARREL CONTINUOUS HINGES – CONCEALED & HALF MORTISE

Full Concealed - 12 Gauge		Nominal Door Height	Net Hinge Height	US32D
 <p><b>UL A5500</b></p> <ul style="list-style-type: none"> <li>• 12 Gauge Stainless Steel</li> <li>• 1/8" Inset</li> <li>• Welded Hospital Tip - <b>Standard</b></li> </ul>	6'8"	78-3/4"	\$640	
	7'0"	83-1/8"		
	7'2"	85"	\$763	
	8'0"	95"		
10'0"	118-3/4"	\$915		
 <p><b>UL A5500WT</b></p> <ul style="list-style-type: none"> <li>• Wide Throw Application</li> <li>• 12 Gauge Stainless Steel</li> <li>• 1/8" Inset</li> <li>• Please specify dimension from center of barrel to Hinge Leaf Edge (5" max)</li> <li>• Welded Hospital Tip - <b>Standard</b></li> </ul>	6'8"	78-3/4"	\$975	
	7'0"	83-1/8"		
	7'2"	85"	\$1,268	
	8'0"	95"		
10'0"	118-3/4"	\$1,690		
 <p><b>UL A5505</b></p> <ul style="list-style-type: none"> <li>• 12 Gauge Stainless Steel</li> <li>• Flush Mount, No Inset</li> <li>• Door Edge Guard on Both Faces</li> <li>• Welded Hospital Tip - <b>Standard</b></li> </ul>	6'8"	78-3/4"	\$830	
	7'0"	83-1/8"		
	7'2"	85"	\$946	
	8'0"	95"		
10'0"	118-3/4"	\$1,128		
 <p><b>UL A5515</b></p> <ul style="list-style-type: none"> <li>• 12 Gauge Stainless Steel</li> <li>• Flush Mount, No Inset</li> <li>• Door Edge Guard on Stop Side Only</li> <li>• Welded Hospital Tip - <b>Standard</b></li> </ul>	6'8"	78-3/4"	\$747	
	7'0"	83-1/8"		
	7'2"	85"	\$862	
	8'0"	95"		
10'0"	118-3/4"	\$1,029		
Half Mortise		Nominal Door Height	Net Hinge Height	US32D
 <p><b>UL A504</b></p> <ul style="list-style-type: none"> <li>• 1/8" Inset</li> <li>• Cover is Clear Anodized Aluminum</li> </ul>	6'8"	78-3/4"	\$366	
	7'0"	83-1/8"		
	7'2"	85"	\$458	
	8'0"	95"		
10'0"	118-3/4"	\$549		
 <p><b>UL A506</b></p> <ul style="list-style-type: none"> <li>• Flush Mount, No Inset</li> <li>• Door Edge Guard on Stop Side Only</li> <li>• Cover is Clear Anodized Aluminum</li> </ul>	6'8"	78-3/4"	\$379	
	7'0"	83-1/8"		
	7'2"	85"	\$473	
	8'0"	95"		
10'0"	118-3/4"	\$568		
Half Surface		Nominal Door Height	Net Hinge Height	US32D
 <p><b>UL A503</b></p> <ul style="list-style-type: none"> <li>• 1/8" Inset</li> <li>• Cover is Clear Anodized Aluminum</li> <li>• Sex Bolts Optional for Door Portion (Page 23)</li> </ul>	6'8"	78-3/4"	\$366	
	7'0"	83-1/8"		
	7'2"	85"	\$458	
	8'0"	95"		
10'0"	118-3/4"	\$549		

\*\* Available on Target 1 – Quick Ship Program – See page 3 for details.

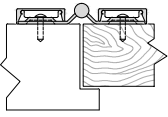

# STAINLESS STEEL PIN & BARREL CONTINUOUS HINGES – FULL SURFACE

Full Surface	Nominal Door Height	Net Hinge Height	US32D
 <p><b>UL</b> <b>A502**</b></p> <ul style="list-style-type: none"> <li>• Flush Mount, No Inset</li> <li>• Covers are Clear Anodized Aluminum</li> <li>• Sex Bolts Optional to Door Portion (Page 23)</li> </ul>	6'8"	78- <sup>3</sup> / <sub>4</sub> "	<b>\$395**</b>
	7'0"	83- <sup>1</sup> / <sub>8</sub> "**	
	7'2"	85"	<b>\$494</b>
	8'0"	95"	
10'0"	118- <sup>3</sup> / <sub>4</sub> "	<b>\$672</b>	

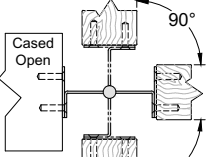
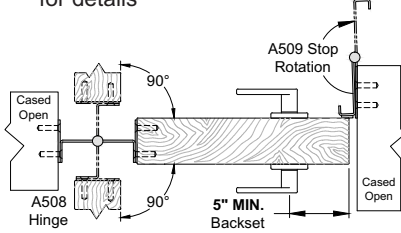
Center Hung - Double Acting	Nominal Door Height	Net Hinge Height	US32D
 <p><b>A508</b></p> <ul style="list-style-type: none"> <li>• Double Acting Hinge for Center Hung Door</li> <li>• Can also be used with ABH A509 Full Length Stainless Steel Rescue Stop – see page 30 for details</li> </ul>  <p>5" MIN. Backset</p>	6'8"	78- <sup>3</sup> / <sub>4</sub> "	<b>\$735</b>
	7'0"	83- <sup>1</sup> / <sub>8</sub> "	
	7'2"	85"	<b>\$919</b>
	8'0"	95"	
	10'0"	118- <sup>3</sup> / <sub>4</sub> "	<b>\$1,250</b>

Parts - Stainless Steel Hinges		Nominal Door Height	Net Hinge Height	List Price
 <p><b>CHS-1</b> - Continuous Hinge Shim</p> <ul style="list-style-type: none"> <li>• Slip-in Installation</li> <li>• 16 Gauge, Stainless Steel</li> </ul> <p><b>CHS-2</b> - Continuous Hinge Shim</p> <ul style="list-style-type: none"> <li>• Hinge Must be Removed for Installation</li> <li>• 16 Gauge, Stainless Steel</li> </ul>	6'8"	78-3/4"	<b>\$45</b>	
	7'0"	83-1/8"		
	7'2"	85"	<b>\$50</b>	
	8'0"	95"		
	10'0"	118-3/4"	<b>\$60</b>	
	6'8"	78-3/4"	<b>\$60</b>	
	7'0"	83-1/8"		
	7'2"	85"	<b>\$70</b>	
	8'0"	95"		
	10'0"	118-3/4"	<b>\$90</b>	

Parts (Fasteners) - Stainless Steel Hinges		List Price
<b>SCREW PACK</b>	Full Concealed Standard Screw Pack (specify hinge model and length)	<b>\$30</b>
<b>SCREW PACK</b>	Half Surface or Full Surface Standard Screw Pack (specify hinge model and length)	<b>\$40</b>
<b>SCREW PACK - SEC</b>	Screw Pack with Security Fasteners (specify hinge model and length)	<b>\$50</b>
<b>SCREW PACK w/ AS</b>	Screw Pack with Adjustable Studs (Specify hinge model & length)	<b>\$65</b>
<b>SCREW PACK w/ AS - SEC</b>	Screw Pack with Security Fasteners & Adjustable Studs (Specify hinge model & length)	<b>\$80</b>
<b>SSH1024FHSDS-500</b>	(500) 10-24 x 7/8" Phillips flat head, undercut self-drilling, thread-forming tek machine screws, stainless steel	<b>\$250</b>
<b>SSH1024FHSDSSEC-500-SEC</b>	(500) 10-24 x 7/8" Pin-in torx flat head, undercut self-drilling, thread-forming tek machine security screws, stainless steel	<b>\$250</b>
<b>SSH10FHWS-500</b>	(500) #10 x 1-1/4" Phillips flat head, undercut wood screws, stainless steel	<b>\$250</b>
<b>SSH10FHWSSEC-500</b>	(500) #10 x 1-1/4" Pin-in torx flat head, undercut wood security screws, stainless steel	<b>\$375</b>
<b>SSH1/420RHSDS-500</b>	(500) 1/4-20 x 3/4" Phillips round head self-drilling, thread-forming tek machine screws, zinc plated	<b>\$375</b>
<b>SSH-AS-500</b>	(500) Adjustable Stud with 10-32 internal thread, 1-3/8" long, with 10-32 x 3/4" Phillips flat head, undercut machine screw	<b>\$1,000</b>



# STAINLESS STEEL PIN & BARREL CONTINUOUS HINGES

**How to Order - Stainless Steel Hinges**

**Example: A500083-US32D x TW4**

**Model** \_\_\_\_\_

**Hinge Height**

- 078 = 78-<sup>3</sup>/<sub>4</sub>"
- 083 = 83-<sup>1</sup>/<sub>2</sub>"
- 085 = 85"
- 095 = 95"
- 118 = 118-<sup>3</sup>/<sub>4</sub>"

**Finishes**

- US32D = Satin Stainless Steel
- US32 = Bright Stainless Steel
- Custom Finish

**Options, if Applicable** \_\_\_\_\_

Electrical Options - Stainless Steel Hinges		List Add
<b>TW4</b>	(4) 30 AWG Wires for Concealed Electrification	<b>\$302</b>
<b>TW8</b>	(8) 30 AWG Wires for Concealed Electrification	<b>\$416</b>
<b>TW12</b>	(12) 30 AWG Wires for Concealed Electrification	<b>\$530</b>
<b>EZ4</b>	(4) 30 AWG Wires with Molex® MicroFit 3.0 Connectors for Concealed Electrification	<b>\$374</b>
<b>EZ8</b>	(8) 30 AWG Wires with Molex® MicroFit 3.0 Connectors for Concealed Electrification	<b>\$489</b>
<b>EZ12</b>	(12) 30 AWG Wires with Molex® MicroFit 3.0 Connectors for Concealed Electrification	<b>\$603</b>
<b>M</b>	Moveable Electrical Access Prep for Electrified Portion (Serviceable)	<b>\$146</b>
<b>PT</b>	Electrical Power Transfer Prep (Specify Electrical Power Transfer Model & Location)	<b>\$83</b>
<b>AMS</b>	Adjustable Monitoring Switch	<b>\$416</b>

Non-Electrical Options - Stainless Steel Hinges		List Add
<b>WEP</b>	Welded End Pins	<b>Standard (N/C)</b>
<b>CB</b>	Clinical Bearings	<b>Standard (N/C)</b>
<b>HT</b>	Welded Hospital Tip for Full Concealed Models (Specify Handing)	<b>\$73</b>
<b>HT</b>	Welded Hospital Tip for Half Surface & Full Surface Models (Specify Handing)	<b>\$104</b>
<b>DD</b>	Dutch Door Prep	<b>\$73</b>
<b>STUD</b>	Security Studs	<b>\$104</b>
<b>AS</b>	Adjustable Studs (A505, A510 & A526 only)	<b>\$50</b>
<b>SEC</b>	Security Fasteners for all Exposed Fasteners (Specify Door & Frame Material)	<b>\$47</b>
<b>CUT</b>	Cut to Custom Length (Specify Length & Handing)	<b>\$42</b>
<b>SNB</b>	Sex Bolts for Surface Mounted Door Portion (A502 & A503 Only)	<b>\$50</b>
<b>SPLICE</b>	118-7/8" - 144" Long Hinge (Specify Length & Handing)	<b>118-3/4" List Price + 118-3/4" List Price + + \$90 List</b>
<b>LL</b>	Lead-Lined Cover (Half Surface & Full Surface - Door Leaf Only)	<b>\$160</b>
<b>RB</b>	Raised Barrel (A500, A505 & A515 Models Only)	<b>\$70</b>
<b>SL</b>	Sheared Leaf for 1-3/8" Thick Door (Concealed Leaf Only)	<b>\$83</b>
<b>ADB</b>	Cut for Automatic Door Bottom (Specify ADB Make & Model)	<b>\$62</b>
<b>ADB-1840</b>	Cut for Automatic Door Bottom with Removeable Section (Specify ADB Make & Model)	<b>\$234</b>
<b>CUSTOM HOLE</b>	Custom Hole Patterns	<b>Contact Factory</b>

Other Finishes - Stainless Steel Hinges			List Add
<b>US32</b>	Bright Stainless Steel Finish	Up to 94-15/16"	<b>\$400</b>
		95" - 118-3/4"	<b>\$500</b>
<b>POWDER COAT</b>	Specify color - Requires customer color sample approval		<b>Contact Factory</b>



# STAINLESS STEEL DOOR EDGE GUARDS

Mortised Edge Guards	Model	Length	US32D	US10*, US10B*, US3*, US32*, US4*
	<b>A528SM</b> • Square Edge • Mortised	Up to 42"	\$90	\$110
		42-1/16" - 95"	\$113	-
		95-1/16" - 118-3/4"	\$141	-
	<b>A528BM</b> • Bevel Edge • "L" Shaped	Up to 42"	\$90	\$110
		42-1/16" - 95"	\$113	-
		95-1/16" - 118-3/4"	\$141	-
	<b>A538SM</b> • Square Edge • Mortised	Up to 42"	\$104	\$124
		42-1/16" - 95"	\$129	-
		95-1/16" - 118-3/4"	\$162	-
	<b>A538BM</b> • Bevel Edge • Mortised	Up to 42"	\$104	\$124
		42-1/16" - 95"	\$129	-
		95-1/16" - 118-3/4"	\$162	-
	<b>A538RM</b> • Radius Edge • Mortised	Up to 42"	\$124	\$144
		42-1/16" - 95"	\$155	-
		95-1/16" - 118-3/4"	\$194	-
	<b>A548SM</b> • Square Edge • Mortised with Astragal	Up to 42"	\$135	\$155
		42-1/16" - 95"	\$169	-
		95-1/16" - 118-3/4"	\$211	-
	<b>A548BM</b> • Bevel Edge • Mortised with Astragal	Up to 42"	\$135	\$155
		42-1/16" - 95"	\$169	-
		95-1/16" - 118-3/4"	\$211	-

Non-Mortised Edge Guards	Model	Length	US32D	US10*, US10B*, US3*, US32*, US4*
	<b>A528S</b> • Square Edge • Non-Mortised	Up to 42"	\$90	\$110
		42-1/16" - 95"	\$113	-
		95-1/16" - 118-3/4"	\$141	-
	<b>A528B</b> • Bevel Edge • "L" Shaped	Up to 42"	\$90	\$110
		42-1/16" - 95"	\$113	-
		95-1/16" - 118-3/4"	\$141	-
	<b>A538S</b> • Square Edge • Non-Mortised	Up to 42"	\$104	\$124
		42-1/16" - 95"	\$129	-
		95-1/16" - 118-3/4"	\$162	-
	<b>A538B</b> • Bevel Edge • Non-Mortised	Up to 42"	\$104	\$124
		42-1/16" - 95"	\$129	-
		95-1/16" - 118-3/4"	\$162	-
	<b>A538R</b> • Radius Edge • Non-Mortised	Up to 42"	\$124	\$144
		42-1/16" - 95"	\$155	-
		95-1/16" - 118-3/4"	\$194	-
	<b>A548S</b> • Square Edge • Non-Mortised with Astragal	Up to 42"	\$135	\$155
		42-1/16" - 95"	\$169	-
		95-1/16" - 118-3/4"	\$211	-
	<b>A548B</b> • Bevel Edge • Non-Mortised with Astragal	Up to 42"	\$135	\$155
		42-1/16" - 95"	\$169	-
		95-1/16" - 118-3/4"	\$211	-

Overlapping, Non-Mortised Edge Guards	Model	Length	US32D	US10*, US10B*, US3*, US32*, US4*
	<b>A528SO</b> • Square Edge • Non-Mortised	Up to 42"	\$120	\$140
	<b>A528BO</b> • Bevel Edge • Non-Mortised	Up to 42"	\$120	\$140
	<b>A538SO</b> • Square Edge • Non-Mortised	Up to 42"	\$140	\$160
	<b>A538BO</b> • Bevel Edge • Non-Mortised	Up to 42"	\$140	\$160

Options - Door Edge Guards	List Add
SEC - Security Fasteners	\$25
Standard Cut-Outs (Contact Factory for Additional Cut-outs Available)	\$25
AS - Adjustable Studs (A538 & A548 Models Only)	\$25
LL - Lead-lined for A548	\$400

\* These finishes are available for lengths longer than 42" by quote only.







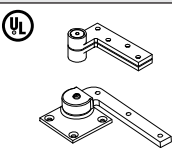
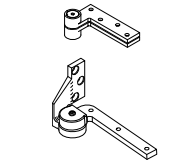
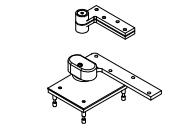
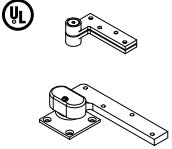
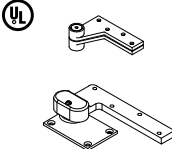
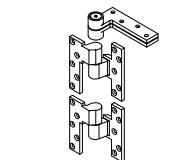
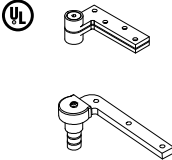
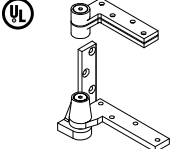
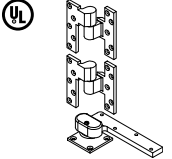





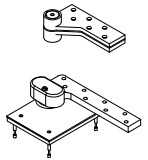

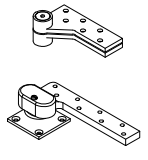

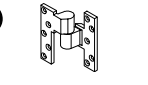

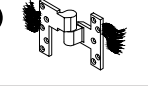

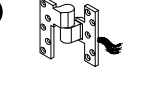

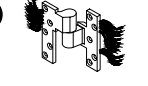

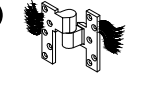
# PIVOTS & PIVOT SETS

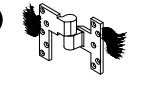
<b>Offset Pivots &amp; Pivot Sets (Specify Handing)</b>		US32D	US26D, US10B	US10, US4, S1, S2, S3, S4, S5, S8	US3, US32, US26
<ul style="list-style-type: none"> <li>• Pivots with UL symbol are fire rated for 3 Hours = <b>Standard (No Upcharge)</b></li> <li>• ABH provides heavy duty needle bearings = <b>Standard (No Upcharge)</b></li> </ul>					
	<b>0117** Pivot Set</b> (Includes 0180 Top & 0117B Bottom) • 3/4" Offset • Up to 300 lbs.	\$259**	\$297	\$323	\$337
	<b>0180** Top Pivot Only</b> (Included in 0117 Pivot Set)	\$130**	\$150	\$162	\$170
	<b>0117B** Bottom Pivot Only</b> (Included in 0117 Pivot Set)	\$181**	\$208	\$226	\$236
	<b>0117.25 Pivot Set</b> (Includes 0180 Top & 0117.25B Bottom) • 3/4" Offset • Up to 250 lbs.	\$280	\$321	\$349	\$364
	<b>0180** Top Pivot Only</b> (Included in 0117.25 Pivot Set)	\$130**	\$150	\$162	\$170
	<b>0117.25B Bottom Pivot Only</b> (Included in 0117.25 Pivot Set)	\$196	\$225	\$244	\$255
	<b>0117.50 Pivot Set</b> (Includes 0180 Top & 0117.50B Bottom) • 3/4" Offset • Up to 650 lbs.	\$612	\$704	\$765	\$796
	<b>0180 Top Pivot Only</b> (Included in 0117.50 Pivot Set)	\$130	\$150	\$162	\$170
	<b>0117.50B Bottom Pivot Only</b> (Included in 0117.50 Pivot Set)	\$428	\$493	\$536	\$557
	<b>0147** Pivot Set</b> (Includes 0180 Top & 0147B Bottom) • 3/4" Offset • Up to 600 lbs.	\$345**	\$397	\$432	\$449
	<b>0180** Top Pivot Only</b> (Included in 0147 Pivot Set)	\$130**	\$150	\$162	\$170
	<b>0147B** Bottom Pivot Only</b> (Included in 0147 Pivot Set)	\$241**	\$278	\$302	\$314
	<b>0147-1.5 Pivot Set</b> (Includes 0180 Top & 0147-1.5B Bottom) • 1-1/2" Offset • Up to 350 lbs.	\$541	\$622	\$676	\$703
	<b>0180-1.5 Top Pivot Only</b> (Included in 0147-1.5 Pivot Set)	\$224	\$257	\$280	\$291
	<b>0147-1.5B Bottom Pivot Only</b> (Included in 0147-1.5 Pivot Set)	\$379	\$435	\$473	\$492
	<b>0165 Pivot Set</b> (Includes (1) 0180 Top & (2) 019 Intermediates) • 3/4" Offset • Up to 300 lbs.	\$488	\$658	\$716	\$744
	<b>0180** Top Pivot Only</b> (Included in 0165 Pivot Set)	\$130**	\$150	\$162	\$170
	<b>019** Intermediate Only</b> (2 Included in 0165 Pivot Set)	\$175**	\$201	\$218	\$227
	<b>0173 Pivot Set</b> (Includes 0180 Top & 0173B Bottom) • 3/4" Offset • Up to 150 lbs.	\$218	\$262	\$272	\$284
	<b>0180** Top Pivot Only</b> (Included in 0173 Pivot Set)	\$130**	\$150	\$162	\$170
	<b>0173B Bottom Pivot Only</b> (Included in 0173 Pivot Set)	\$153	\$183	\$190	\$199
	<b>0195** Pivot Set</b> (Includes 0180 Top & 0195B Bottom) • 3/4" Offset • Up to 450 lbs.	\$328**	\$376	\$410	\$426
	<b>0180** Top Pivot Only</b> (Included in 0195 Pivot Set)	\$130**	\$150	\$162	\$170
	<b>0195B** Bottom Pivot Only</b> (Included in 0195 Pivot Set)	\$230**	\$263	\$287	\$298
	<b>0547 Pivot Set</b> (Includes (2) 019 Intermediates & (1) 0147B Bottom) • 3/4" Offset • Up to 450 lbs.	\$521	\$599	\$651	\$677
	<b>019** Intermediate Only</b> (2 Included in 0165 Pivot Set)	\$175**	\$201	\$218	\$227
	<b>0147B** Bottom Pivot Only</b> (Included in 0547 Pivot Set)	\$242**	\$278	\$302	\$314

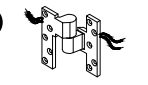
\*\* Available on Target 1 – Quick Ship Program – See page 3 for details.

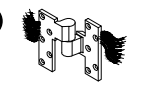

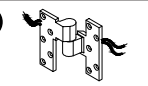
# PIVOTS & PIVOT SETS

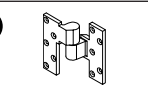
<b>Offset Pivots &amp; Pivot Sets (Specify Handing)</b>		US32D	US26D, US10B	US10, US4, S1, S2, S3, S4, S5, S8	US3, US32, US26
<ul style="list-style-type: none"> <li>• ABH provides heavy duty needle bearings = <b>Standard (No Upcharge)</b></li> <li>• Pivots with UL symbol are fire rated for 3 Hours = <b>Standard (No Upcharge)</b></li> </ul>					
 	<b>L0117 Pivot Set</b> (Includes L0180 Top & L0117B Bottom) <ul style="list-style-type: none"> <li>• 3/4" Offset</li> <li>• For Use on Lead-lined Doors</li> <li>• Up to 1,750 lbs.</li> </ul>	\$834	\$959	\$1,043	\$1,084
	<b>L0180 Top Pivot Only</b> (Included in 0195 Pivot Set)	\$224	\$257	\$280	\$291
	<b>L0117B Bottom Pivot Only</b> (Included in 0195 Pivot Set)	\$584	\$671	\$730	\$759
 	<b>L0147 Pivot Set</b> (Includes L0180 Top & L0147B Bottom) <ul style="list-style-type: none"> <li>• 3/4" Offset</li> <li>• Up to 1,000 lbs.</li> <li>• For Use on Lead-lined Doors</li> </ul>	\$541	\$622	\$676	\$703
	<b>L0180 Top Pivot Only</b> (Included in 0195 Pivot Set)	\$224	\$257	\$280	\$291
	<b>L0147B Bottom Pivot Only</b> (Included in 0195 Pivot Set)	\$379	\$435	\$473	\$492
<b>Offset Intermediate Pivots (Specify Handing)</b>		US32D	US26D, US10B	US10, US4, S1, S2, S3, S4, S5, S8	US3, US32, US26
<ul style="list-style-type: none"> <li>• Pivots with UL symbol are fire rated for 3 Hours = <b>Standard (No Upcharge)</b></li> <li>• ABH provides heavy duty needle bearings = <b>Standard (No Upcharge)</b></li> <li>• NFPA 80, Section 3-3.8 requires some fire doors 60"-90" tall to have one intermediate pivot, with another intermediate for each additional 30" in height.</li> </ul>					
 	<b>019**</b> <ul style="list-style-type: none"> <li>• 3/4" Offset</li> </ul>	\$175**	\$201	\$218	\$227
 	<b>019-1.5</b> <ul style="list-style-type: none"> <li>• 1-1/2" Offset</li> </ul>	\$276	\$317	\$344	\$359
 	<b>CM019</b> <ul style="list-style-type: none"> <li>• 3/4" Offset</li> <li>• Concealed Monitoring Switch Only (No Power Transfer)</li> </ul>	\$493	\$567	\$617	\$641
 	<b>CME019</b> <ul style="list-style-type: none"> <li>• 3/4" Offset</li> <li>• Monitoring Switch &amp; Electrified (8) 30 AWG Wire Power Transfer</li> </ul>	\$645	\$742	\$806	\$838
 	<b>E019</b> <ul style="list-style-type: none"> <li>• 3/4" Offset</li> <li>• <b>Electrified</b> - (8) 30 AWG Wire Power Transfer</li> </ul>	\$447	\$515	\$560	\$581
 	<b>E019-1.5</b> <ul style="list-style-type: none"> <li>• 1-1/2" Offset</li> <li>• <b>Electrified</b> - (8) 30 AWG Wire Power Transfer</li> </ul>	\$660	\$759	\$825	\$858
 	<b>E019U</b> <ul style="list-style-type: none"> <li>• 3/4" Offset</li> <li>• <b>Electrified</b> - (2) 18 AWG Wire Power Transfer for High Inrush</li> </ul>	\$716	\$823	\$894	\$930
 	<b>EL019</b> <ul style="list-style-type: none"> <li>• 3/4" Offset - for Use on Lead-lined Doors</li> <li>• <b>Electrified</b> - (8) 30 AWG Wire Power Transfer</li> </ul>	\$660	\$759	\$825	\$858
 	<b>EL019U</b> <ul style="list-style-type: none"> <li>• 3/4" Offset - for Use on Lead-lined Doors</li> <li>• <b>Electrified</b> - (2) 18 AWG Wire Power Transfer for High Inrush</li> </ul>	\$884	\$988	\$1,040	\$1,123
 	<b>L019</b> <ul style="list-style-type: none"> <li>• 3/4" Offset</li> <li>• For Use on Lead-lined Doors</li> </ul>	\$276	\$317	\$344	\$359

\*\* Available on Target 1 – Quick Ship Program – See page 3 for details.



# PIVOTS & PIVOT SETS

Center Hung Pivots (Non-Handed)		US32D	US26D, US10B	US10, US4, S1, S2, S3, S4, S5, S8	US3, US32, US26
	<b>0117.75 Pivot Set</b> (Includes 0345 Top & 0117.75B Bottom) • Up to 600 lbs.	\$737	\$884	\$963	\$1,007
	<b>0345 Top Pivot Only</b> (Included in 0117.75 Pivot Set)	\$312	\$359	\$374	\$395
	<b>0117.75B Bottom Pivot Only</b> (Included in 0117.75 Pivot Set)	\$516	\$619	\$674	\$705
	<b>0127** Pivot Set</b> (Includes 0320 Top & 0127B Bottom) • Up to 200 lbs.	\$172**	\$198	\$214	\$224
	<b>0320** Top Pivot Only</b> (Included in 0127 Pivot Set)	\$93**	\$106	\$115	\$120
	<b>0127B** Bottom Pivot Only</b> (Included in 0127 Pivot Set)	\$120**	\$139	\$150	\$157
	<b>0128** Pivot Set</b> (Includes 0320 Top & 0128B Bottom) • Up to 250 lbs.	\$172**	\$198	\$214	\$224
	<b>0320** Top Pivot Only</b> (Included in 0128 Pivot Set)	\$93**	\$106	\$115	\$120
	<b>0128B** Bottom Pivot Only</b> (Included in 0128 Pivot Set)	\$120**	\$139	\$150	\$157
	<b>0327 Pivot Set</b> (Includes 0321 Top & 0327B Bottom) • Up to 135 lbs.	\$151	\$172	\$185	\$192
	<b>0321 Top Pivot Only</b> (Included in 0327 Pivot Set)	\$78	-	-	-
	<b>0327B Bottom Pivot Only</b> (Included in 0327 Pivot Set)	\$106	\$120	\$130	\$134
	<b>0370 Pivot Set</b> (Includes 0340 Top & 0370B Bottom) • Up to 500 lbs.	\$244	\$281	\$306	\$318
	<b>0340 Top Pivot Only</b> (Included in 0370 Pivot Set)	\$101	\$116	\$126	\$131
	<b>0370B Bottom Pivot Only</b> (Included in 0370 Pivot Set)	\$171	\$197	\$214	\$223
	<b>E0117.75 Pivot Set</b> (Includes E0345 Top & 0117.75B Bottom) • Up to 600 lbs. • Includes <b>Electrified</b> Top Pivot	\$1,137	\$1,284	\$1,363	\$1,407
	<b>E0345 Top Pivot Only</b> (Included in E0117.75 Pivot Set) • <b>Electrified</b> Top Pivot - (8) 30 AWG Wire Power Transfer	\$742	\$790	\$840	\$860
	<b>E0128 Pivot Set</b> (Includes E0320 Top & 0128B Bottom) • Up to 250 lbs. • Includes <b>Electrified</b> Top Pivot	\$487	\$550	\$592	\$612
	<b>E0320 Top Pivot Only</b> (Included in E0128 Pivot Set) • <b>Electrified</b> Top Pivot - (8) 30 AWG Wire Power Transfer	\$407	\$470	\$512	\$532
	<b>E0370 Pivot Set</b> (Includes E0340 Top & 0370B Bottom) • Up to 500 lbs. • Includes <b>Electrified</b> Top Pivot	\$572	\$658	\$715	\$744
	<b>E0340 Top Pivot Only</b> (Included in E0370 Pivot Set) • <b>Electrified</b> Top Pivot - (8) 30 AWG Wire Power Transfer	\$418	\$481	\$523	\$543

\*\* Available on **Target 1 – Quick Ship Program** – See page 3 for details.

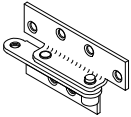

# PIVOTS & PIVOT SETS

Reinforcing Pivot		US2G - Zinc Plated
	<b>0923**</b> <ul style="list-style-type: none"> <li>• 1/8" Inset (Replace 4-1/2" Butt Hinge)</li> <li>• Full Surface Reinforcing Pivot</li> <li>• Door weight up to 300 lbs.</li> </ul>	<b>\$75**</b>

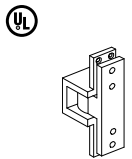
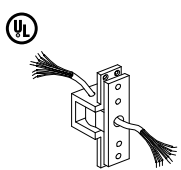
Pocket Pivots (Non-Handed)		US32D	US26D, US10B	US10, US4, S1, S2, S3, S4, S5, S8	US3, US32, US26
	<b>0519**</b> <ul style="list-style-type: none"> <li>• Pocket Door Application</li> </ul>	<b>\$317**</b>	<b>\$365</b>	<b>\$396</b>	<b>\$413</b>
	<b>E0519</b> <ul style="list-style-type: none"> <li>• Pocket Door Application</li> <li>• <b>Electrified</b> - (8) 30 AWG Wire Power Transfer</li> </ul>	<b>\$780</b>	<b>\$898</b>	<b>\$976</b>	<b>\$1,014</b>

Options - Pivots & Pivot Sets	List Add
<b>Extended Spindle</b> for Bottom Pivot (1/8" Increments up to 2" Longer than Standard)	<b>\$172</b>
<b>Extended Pin</b> for Top Pivot (1/8" Increments up to 3/4" Longer than Standard)	<b>\$125</b>
<b>EZ Connect</b> - Add Molex® "EZ" Connectors to Electrified Pivots	<b>\$78</b>
<b>SEC</b> - Security Fasteners Provided for All Exposed Fasteners - Single Pivot	<b>\$31</b>
<b>SEC</b> - Security Fasteners Provided for All Exposed Fasteners - Pivot Set	<b>\$52</b>

Parts - Pivots & Pivot Sets	List Price
<b>SCREW PACK</b> - Single Pivot - Standard Screw Pack for Single Pivot (Specify Model & Finish)	<b>\$20</b>
<b>SCREW PACK</b> - Pivot Set - Standard Screw Pack for Pivot Set (Specify Model & Finish)	<b>\$35</b>
<b>SCREW PACK-SEC</b> - Single Pivot - Security Screw Pack for Single Pivot (Specify Model & Finish)	<b>\$30</b>
<b>SCREW PACK-SEC</b> - Pivot Set - Security Screw Pack for Pivot Set (Specify Model & Finish)	<b>\$50</b>



# RESCUE HARDWARE

DS4510  
DS4520

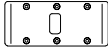

DS4530  
DS4540

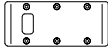

SDS4500



Double-Lipped Strikes • Cylindrical Latch		US32D	US10, US10B, US4	US3, US32
DS4510	5-3/4" x 2-3/4" - Center Hung	\$66	\$80	\$94
DS4520	6-3/4" x 2-3/4" - Center Hung			
DS4530	5-3/4" x 2-3/4" - 1/8" Inset			
DS4540	6-3/4" x 2-3/4" - 1/8" Inset			
SDS4500	Special Layout - <b>Check ABH catalog or go to <a href="http://www.abhmfg.com">www.abhmfg.com</a> for 100s of custom layouts ready-to-go!</b>	Contact Factory		

SDSM4500

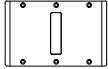

Double-Lipped Strikes • Mortise Lock		US32D	US10, US10B, US4	US3, US32
SDSM4500	Special Layout - <b>Check ABH catalog or go to <a href="http://www.abhmfg.com">www.abhmfg.com</a> for 100s of custom layouts ready-to-go!</b>	Contact Factory		

CR4550  
CR4560



CR4570  
CR4580



SCR4550



Combination Double-Lipped Strike & Rescue Stops • Cylindrical Latch • Half-Moon Style		US32D	US10, US10B, US4	US3, US32
CR4550	5-3/4" x 2-3/4" - Center Hung	\$199	\$248	\$263
CR4560	6-3/4" x 2-3/4" - Center Hung			
CR4570	5-3/4" x 2-3/4" - 1/8" Inset			
CR4580	6-3/4" x 2-3/4" - 1/8" Inset			
SCR4550	Special Layout - <b>Check ABH catalog or go to <a href="http://www.abhmfg.com">www.abhmfg.com</a> for 100s of custom layouts ready-to-go!</b>	Contact Factory		

SCRM4550



Combination Double-Lipped Strike & Rescue Stops • Mortise Lock • Half-Moon Style		US32D	US10, US10B, US4	US3, US32
SCRM4550	Special Layout - <b>Check ABH catalog or go to <a href="http://www.abhmfg.com">www.abhmfg.com</a> for 100s of custom layouts ready-to-go!</b>	Contact Factory		

CR4591  
CR4592

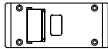

CR4593  
CR4594

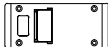

SCR4590



Combination Double-Lipped Strike & Rescue Stops • Cylindrical Latch • Flipper Style		US32D	US10, US10B, US4	US3, US32
CR4591	5-3/4" x 2-3/4" - Center Hung	\$199	\$248	\$263
CR4592	6-3/4" x 2-3/4" - Center Hung			
CR4593	6-3/4" x 2-3/4" - 1/8" Inset			
CR4594	5-3/4" x 2-3/4" - 1/8" Inset			
SCR4590	Special Layout - <b>Check ABH catalog or go to <a href="http://www.abhmfg.com">www.abhmfg.com</a> for 100s of custom layouts ready-to-go!</b>	Contact Factory		

SCRM4590

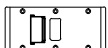

Combination Double-Lipped Strike & Rescue Stops • Mortise Lock • Flipper Style		US32D	US10, US10B, US4	US3, US32
SCRM4590	Special Layout - <b>Check ABH catalog or go to <a href="http://www.abhmfg.com">www.abhmfg.com</a> for 100s of custom layouts ready-to-go!</b>	Contact Factory		



# RESCUE HARDWARE

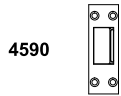

Rescue Stop - Stand Alone		US32D	US10, US10B, US4	US3, US32
<b>4590</b>	Rescue Stop Only (Strike not Included)	\$130	\$176	\$193

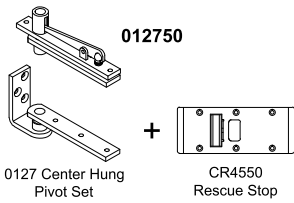

Center Hung Pivot & Combination Double-Lipped Strike Rescue Stop Set (See page 27 for details on the center hung pivot sets)		US32D	US10, US10B, US4	US3, US32
<b>012750</b>	0127 Pivot Set & CR4550 Rescue Stop	\$352	\$429	\$473
<b>012760</b>	0127 Pivot Set & CR4560 Rescue Stop			
<b>012770</b>	0127 Pivot Set & CR4570 Rescue Stop			
<b>012780</b>	0127 Pivot Set & CR4580 Rescue Stop			
<b>012850</b>	0128 Pivot Set & CR4550 Rescue Stop	\$352	\$429	\$473
<b>012860</b>	0128 Pivot Set & CR4560 Rescue Stop			
<b>012870</b>	0128 Pivot Set & CR4570 Rescue Stop			
<b>012880</b>	0128 Pivot Set & CR4580 Rescue Stop			
<b>012791</b>	0127 Pivot Set & CR4591 Rescue Stop	\$352	\$429	\$473
<b>012792</b>	0127 Pivot Set & CR4592 Rescue Stop			
<b>012793</b>	0127 Pivot Set & CR4593 Rescue Stop			
<b>012794</b>	0127 Pivot Set & CR4594 Rescue Stop			
<b>012891</b>	0128 Pivot Set & CR4591 Rescue Stop	\$352	\$429	\$473
<b>012892</b>	0128 Pivot Set & CR4592 Rescue Stop			
<b>012893</b>	0128 Pivot Set & CR4593 Rescue Stop			
<b>012894</b>	0128 Pivot Set & CR4594 Rescue Stop			

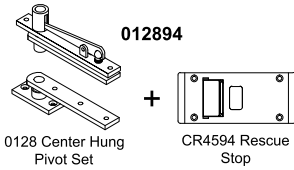
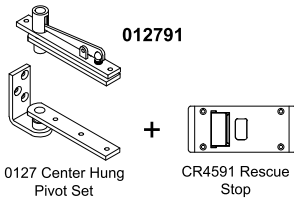
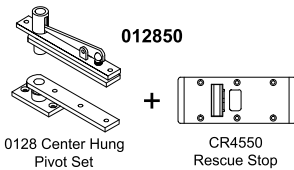

A509 Full Length Rescue Stop - Stainless Steel		US32D
<ul style="list-style-type: none"> <li>• Full Length - Eliminate Gaps on Lock Side</li> <li>• Welded Hospital Tip comes <b>Standard - No additional Charge</b></li> <li>• For use on doors with minimum 3-3/4" latch backset</li> <li>• Can be used with A508 Stainless Steel Center Hung Continuous Hinge (see page 22 for details)</li> </ul>		
<b>A509078</b>	78-3/4" Net Length for 6'8" Nominal Door	\$680
<b>A509083</b>	83-1/8" Net Length for 7'0" Nominal Door	\$680
<b>A509085</b>	85" Net Length for 7'2" Nominal Door	\$850
<b>A509095</b>	95" Net Length for 8'0" Nominal Door	\$850
<b>A509118</b>	118-3/4" Net Length for 10'0" Nominal Door	\$1,020

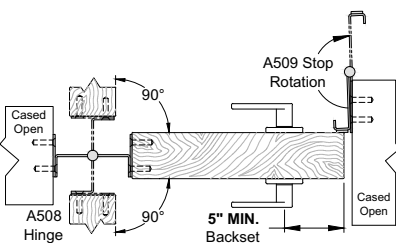
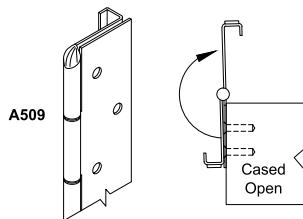

# MISCELLANEOUS PRODUCTS

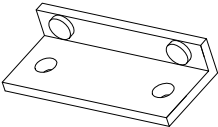
<b>1801 Applied Stop</b>	<b>US32D</b>	<b>US10, US10B, US4</b>	<b>US3, US32</b>
	<b>\$36</b>	<b>\$42</b>	<b>\$48</b>

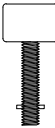
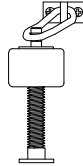
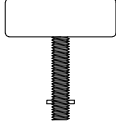
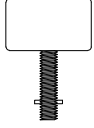
<b>1803 Floor Stops</b>	
	
1803 - \$40	1803HO - \$65
	
H1803 - \$60	EHD1803 - \$82

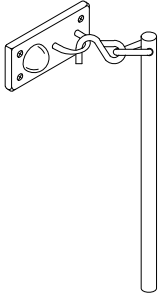
<b>1804 Pipe Stop &amp; Holder</b>
<b>US32D=\$202</b>

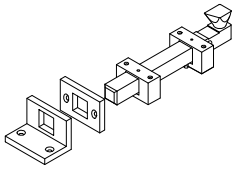
<b>HD1805 Heavy Duty Surface Bolts</b>			<b>US32D</b>
	<b>HD1825TB</b>	12" with Top & Bottom Strike	<b>\$148</b>
	<b>HD1835TB</b>	24" with Top & Bottom Strike	<b>\$190</b>
	<b>HD1845TB</b>	36" with Top & Bottom Strike	<b>\$320</b>

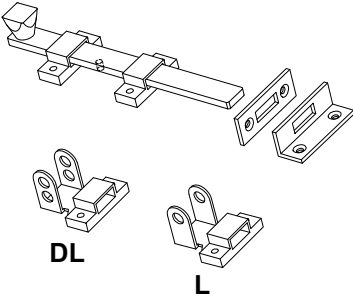
	<b>1805 Surface Bolts</b>		<b>US32D</b>
	<b>1815TB</b>	8" with Top & Bottom Strike	<b>\$79**</b>
	<b>1825TB</b>	12" with Top & Bottom Strike	<b>\$101</b>
	<b>1835TB</b>	24" with Top & Bottom Strike	<b>\$199</b>
	<b>Options - 1805 Surface Bolts</b>		<b>List Add</b>
	<b>L</b>	Single Locking Bracket	<b>\$20</b>
	<b>DL</b>	Double Locking Bracket	<b>\$35</b>
	<b>SEC</b>	Security Fasteners for all Exposed Screws	<b>\$30</b>
	<b>SNB</b>	Sex Bolt Fasteners	<b>\$40</b>

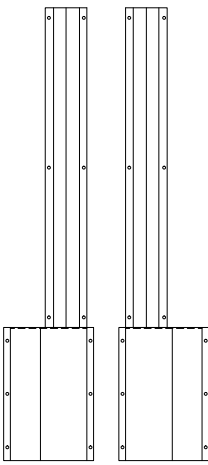
<b>1811 Vertical Rod Protectors &amp; Latch Bolt Covers</b>			<b>US32D</b>
	<b>1811</b>	(2) 24" Vertical Rod Covers + (1) RH Latch Bolt Cover + (1) LH Latch Bolt Cover	<b>\$265</b>
	<b>1811-36</b>	(2) 36" Vertical Rod Covers + (1) RH + (1) LH Latch Bolt Cover	<b>\$304</b>
	<b>1811-48</b>	(2) 48" Vertical Rod Covers + (1) RH + (1) LH Latch Bolt Cover	<b>\$382</b>
	<b>1812</b>	(1) 24" Vertical Rod Cover + (1) RH Latch Bolt Cover	<b>\$132</b>
	<b>1813</b>	(1) 24" Vertical Rod Cover + (1) LH Latch Bolt Cover	<b>\$132</b>
	<b>1812-36</b>	(1) 36" Vertical Rod Cover + (1) RH Latch Bolt Cover	<b>\$156</b>
	<b>1813-36</b>	(1) 36" Vertical Rod Cover + (1) LH Latch Bolt Cover	<b>\$156</b>
	<b>1812-48</b>	(1) 48" Vertical Rod Cover + (1) RH Latch Bolt Cover	<b>\$208</b>
	<b>1813-48</b>	(1) 48" Vertical Rod Cover + (1) LH Latch Bolt Cover	<b>\$208</b>
	<b>1812-1</b>	(1) 24" Vertical Rod Protector	<b>\$83</b>
	<b>1812-1-36</b>	(1) 36" Vertical Rod Protector	<b>\$104</b>
	<b>1812-1-48</b>	(1) 48" Vertical Rod Protector	<b>\$135</b>
	<b>1812-2</b>	(1) RH Latch Bolt Cover	<b>\$88</b>
<b>1812-3</b>	(1) LH Latch Bolt Cover	<b>\$88</b>	

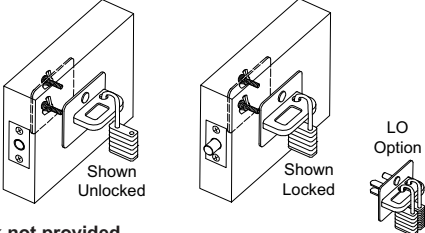
	<b>Slide Bolts</b>		<b>US32D</b>
	<b>1884</b>	Slide Bolt - 2-3/4" Backset & T-Strike (161 Prep)	<b>\$97**</b>
	<b>1884A**</b>	Slide Bolt - 2-3/4" Backset & ASA Strike (161 Prep)	
	<b>1888</b>	Slide Bolt - 2-3/8" Backset & T-Strike (160 Prep)	
	<b>1888A</b>	Slide Bolt - 2-3/8" Backset & ASA Strike (160 Prep)	
	<b>Options - Slide Bolts</b>		<b>List Add</b>
<b>LO</b>	Lock-Out Option (Additional hole for double locking)	<b>\$100</b>	

\*\* Available on **Target 1 - Quick Ship Program** - See page 3 for details.

Innovation, Quality, Customer Service ... **A:H**® *Makes Life Simple* 2/6/17

Tel (630) 875-9900

Fax (800) 932-9224

www.abhmf.com



